

Digital Fiber Sensor

E3X-DA-S Series

Active Threshold Control models (E3X-DA□□AT-S)

Instruction Sheet

Thank you for selecting an OMRON product. This sheet primarily describes precautions required in installing and operating the product.

- The specialist who has the knowledge of electricity must treat.
- Please often read this manual, and use it correctly after it understands enough.
- Please keep this manual importantly to refer at any time.

© OMRON Corporation 2004 All Rights Reserved.

1636510-0A(2/2)

Precautions for Safe Use

Please observe the following precautions for safe use of the product.

- Do not use the Amplifier Unit in environments subject to flammable or explosive gases.
- Do not use the Amplifier Unit in environments subject to exposure to water, oil, chemicals, etc.
- Do not attempt to disassemble, repair, or modify the Amplifier Unit in any way.
- Do not apply voltages or currents that exceed the rated ranges.
- Wire the Amplifier Unit correctly, e.g., do not reverse the polarity of the power supply.
- Connect the load correctly.
- Do not short both ends of the load.
- Do not use the Amplifier Unit if the case is damaged.
- When disposing of the Amplifier Unit, treat it as industrial waste.

Precautions for Correct Use

Please observe the following precautions to prevent failure to operate, malfunction, or undesirable effects on product performance.

- The optical fibers are made out of methacrylic resin. Do not use them in atmospheres where organic solvents are present.
- Wire the Amplifier Unit separately from power supply or high-voltage lines. If the Amplifier Unit wiring is wired together with or placed in the same duct as high-power lines, inductive noise may cause operating errors or damage the Amplifier Unit.
- Do not extend the cable to more than 100 m, and use a wire size of 0.3 mm² or larger for the extension cable.
- The Amplifier Unit is ready to operate 200 ms after the power supply is turned ON. If the Amplifier Unit and load are connected to power supplies separately, turn ON the power supply to the Amplifier Unit first.
- Always keep the protective cover in place when using the Amplifier Unit.
- Connector Short-circuit Protection (for Amplifier Units with Connectors)
To prevent electric shock or short-circuits, attach the protector seals provided with E3X-CN-series Connectors to the sides of power supply connectors that are not being used.
- Always turn OFF the power supply before connecting, separating, or adding Amplifier Units.
- If the data is not written to the EEPROM correctly due to a power failure or static-electric noise, initialize the settings using the keys on the Amplifier Unit.
- Using a Mobile Console
Use the E3X-MC11-SV2 Mobile Console for the E3X-DA-S series Amplifier Units. However, there is a function which cannot be used in part. Other Mobile Consoles, such as the E3X-MC11, cannot be used.
- Optical communications are not possible with an E3X-DA-N Amplifier Unit.
- Depending on the application environment, time may be required for the incident light level to stabilize after the power supply is turned ON.
- Do not use thinners, benzene, acetone, or kerosene for cleaning the Amplifier Unit.
- Do not pull or apply excessive pressure or force (exceeding 9.8 N · m) on the Fiber Unit when it is mounted to the Amplifier Unit.
- Output pulses may occur when the power is interrupted and so turn OFF the power to the load or load line before turning OFF the power to the Sensor.
- At the time of ATC effective, when work speed is slow, a threshold may follow a work and detection may be correctly impossible for it. Please make a threshold ratio small or not effective an ATC function.

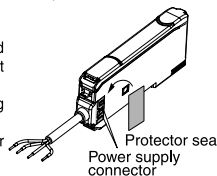

Confirming the Package Contents

- Amplifier Unit: 1
- Instruction Sheet (this sheet): 1

1. Ratings and Specifications

Type	Advanced, ATC function models	
Connection method	Prewired	Separate connector*1
Model number	NPN	E3X-DA11AT-S
	PNP	E3X-DA41AT-S
Supply voltage	12 to 24 VDC ±10%, ripple (p-p) 10% max.	
Power consumption	1.080 mW max. (45 mA max. at 24 V)	
Control output	Open collector (26.4 V DC max.);	
	load current: 50 mA max.; residual voltage: 1 V max.	
Timer	OFF, OFF-delay, ON-delay, or one-shot	
Timer time	1 ms to 5 s	
Differential detection mode	Supported	
Power tuning	Supported	
APC(Auto Power Control)function	Supported(High-speed control method for emission current)	
ATC(Active Threshold Control) function	Supported(Threshold updates at intervals of about 30 seconds)	
Mutual interference Prevention*2	Supported(optical communications sync method) Possible for up to 10 Units	
I/O settings	Output setting (channel 2 output, area output, self-diagnosis output, or ATC Error output)	

*1: When using individually or as a master, obtain the E3X-CN21 Master Connector (4-conductor), and when using as a slave, obtain the E3X-CN22 Slave Connector (2-conductor), Either Connector can be used.
*2: Communications are disabled if SHS is selected for the detection mode, and the communications functions for mutual interference prevention and the Mobile Console will not function.

2. Nomenclature

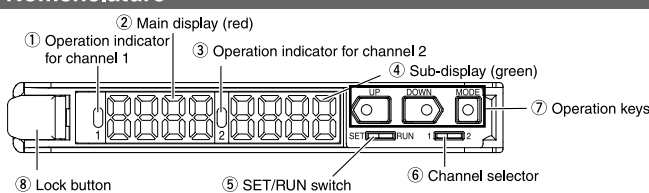

- Lit when the output for channel 1 is ON.
- Displays the incident light level or the function name.
- Lit when the output for channel 2 is ON.
- Displays supplemental detection information, the setting of a function, etc.
- Used to switch the mode.
- Used to select the channel to display or set.
- Used to change the display, set functions, etc.
- Used to connect and disconnect the Fiber Unit.

3. Basic Operating Information

Setting the Mode

The mode is set using the SET/RUN switch. Set this switch according to the operation to be performed.

Mode	Description
SET	Select to set detection conditions, to teach the threshold value, etc.
RUN	Select for actual detection operation or to set the following: Manual adjustment of threshold ratio, starting ATC thres holds, teaching power adjustment, zero reset, or key lock.

Key Operations

The operation keys are used to switch the displays and set detection conditions. The functions of the keys depend on the current mode.

Key	Function	
	RUN mode	SET mode
UP key 	Increases the threshold or threshold ratio.	Depends on the setting. • Executes teaching. • Changes the setting forward.
DOWN key 	Decreases the threshold or threshold ratio.	Depends on the setting. • Executes teaching. • Changes the setting in reverse.
MODE key 	Depends on the MODE key setting. • Starting ATC(default setting). • Teaching • Executes power tuning. • Executes a zero reset.	Switches the function to be set on the display.

Time to Press Keys
If a specific time for pressing a key is not given in a procedure, press the key for approximately 1 second. For example, if the procedure says i press the UP key, i then press the UP key for approximately 1 second and then release it.

Reading Displays

The information displayed on the main display and sub-display depends on the current mode. For the default settings, the RUN mode displays will appear when the power supply is turned ON for the first time.

Mode	Main display (red)	Sub-display (green)
SET	Displays the incident light level, * function name, or other information depending on the key operation. *The incident light level will be displayed even if DIFF (differential operation) is set for the detection method.	Displays threshold value* or the setting of the function displayed on the main display depending on the key operation. *The threshold value for the change in the incident light level will be displayed if DIFF (differential operation) is set for the detection method. For the default setting, the current threshold value will be displayed.
RUN (See note.)	ATC ON For the default setting, the current incident light level will be displayed. (default setting)	For the default setting, the current threshold value will be displayed. (default setting)
	ATC OFF The current incident light level will be displayed. The change in the incident light level will be displayed when DIFF (differential operation) is set for the detection mode.	The current threshold value will be displayed. The threshold value for the change in the incident light level will be displayed if DIFF (differential operation) is set for the detection method.

Note: The information that appears on the displays can be set using the display switch function. Refer to 5. Detailed Settings.

4. Basic Settings

1. Setting the Operation Mode

Select either light-ON or dark-ON operation. Set as the operation mode in SET mode. Refer to 5. Detailed Settings.

Selection	Description
LON (light-ON) (default)	The output will turn ON when the incident light level is above the threshold. If DIFF (differential operation) is set for the detection method, the output will turn ON when an edge is detected.
DON (dark-ON)	The output will turn ON when the incident light level is below the threshold. If DIFF (differential operation) is set for the detection method, the output will turn OFF when an edge is detected.

2. Adjusting the Power (as Required)

Power tuning can be used to adjust the incident light level that is currently being received to the power tuning target value (default: 2,000). Before tuning ON the power, always secure the detection object and Head and be sure that the incident light level is stable.

Setting Method

Confirm that the MODE key setting is PTUN (power tuning) in advance. ATC is the default setting. Refer to 5. Detailed Settings.

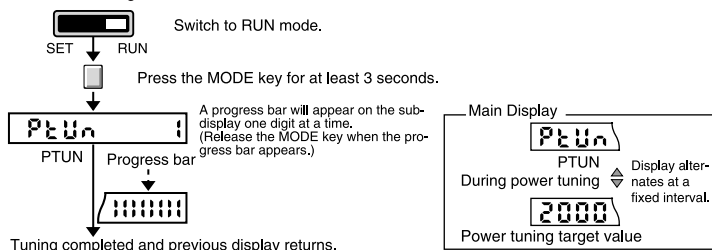

The power tuning target value can be changed. Refer to 5. Detailed Settings.

If power is tuned when SHS is selected for the detection method, the power will be set to the minimum value.

Power tuning Errors
An error has occurred if one of the following displays appears after the progress bar is displayed.

	Over Error The incident light level is too low for the power tuning target value. The power can be increased up to approximately 5 times the incident light level without power tuning.
	Bottom Error The incident light level is too high for the power tuning target value. The power can be decreased down to approximately 1/25th the incident light level without power tuning.

Clearing Method

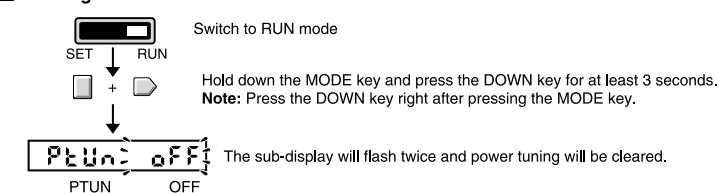

3. Setting Thresholds

Effective set for ATC function

The threshold ratio is adjusted and the threshold is updated by the incident level every about 30 seconds by ATC start. Confirm that the MODE key setting is ATC in advance. ATC is the default setting. Refer to 5. Detailed Settings.

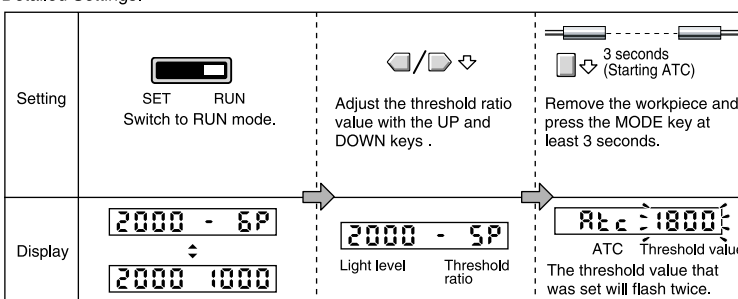

Disable ATC function

1) Manually Setting

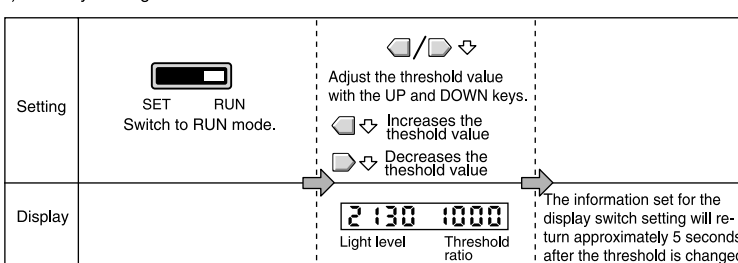

2) Teaching

Teaching With and Without a Workpiece

Teaching can be performed twice, once with and once without a workpiece, and the value between the two measured values is set as the threshold. RUN mode and SET mode – each mode can be set up.

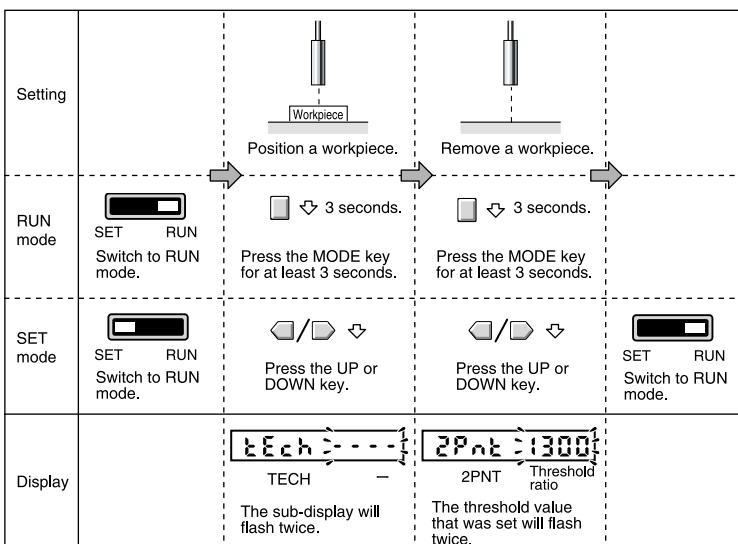

If DIFF (differential operation) is set for the detection method, the threshold value will be set to half of the difference between the two measured values.

Automatic-teaching (It sets up at move work.)

While continuing pushing a key, the middle of the detected maximum and the minimum value can be set up as a threshold.

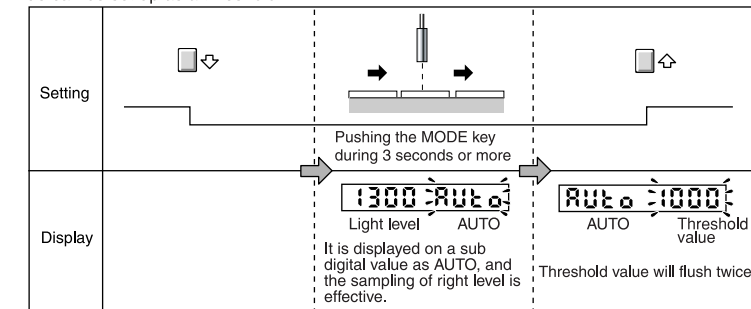

This method cannot be used to set the threshold when the detection method has been set to DIFF (differential operation).

Teaching for Through-beam Sensor Heads

Teaching for a Through-beam Sensor Head is performed without a workpiece. A value about 6% less than the incident light level with no workpiece is set as the threshold value. This method is ideal to stably detect very small differences in light level.

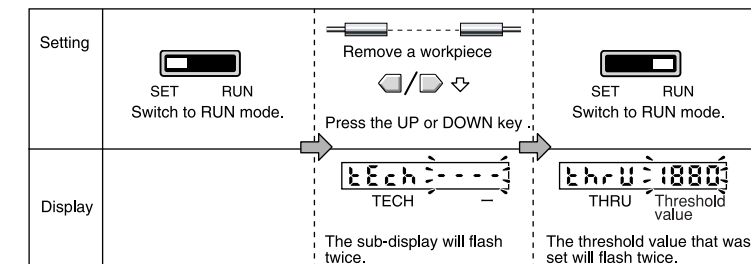

If DIFF (differential operation) is set for the detection method, the threshold value will be set to the minimum value below the incident light level without a workpiece that will enable stable detection.

Teaching for Reflective Sensor Heads

Teaching for a Reflective Sensor Head is performed without a workpiece (i.e., for the background). A value about 6% greater than the incident light level is set as the threshold value. This method is ideal to stably detect very small differences in light level.

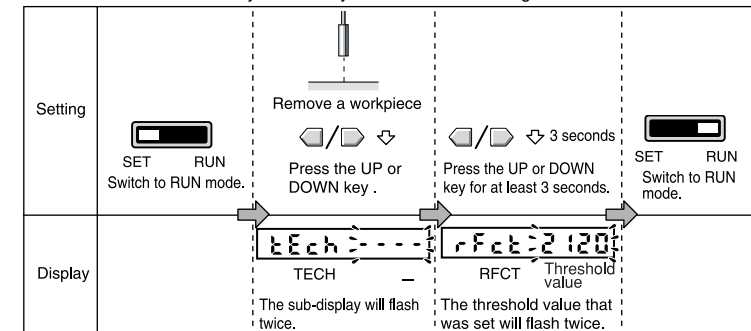

If DIFF (differential operation) is set for the detection method, the threshold value will be set to the minimum value above the incident light level without a workpiece that will enable stable detection.

Setting the Threshold at the Maximum Sensitivity

The threshold can be set at the maximum sensitivity. This is convenient when using the longest sensing distance.

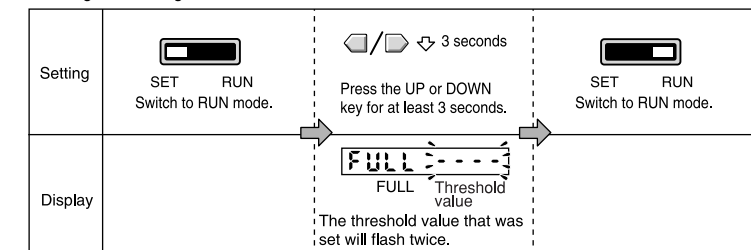

It does not matter whether or not there is a workpiece. The value that is set will depend on the detection method and power adjustment settings. This method cannot be used to set the threshold when the detection method has been set to DIFF (differential operation).

Teaching Error

After performing teaching, when the following is displayed on sub digital display, the error has occurred. However, the threshold might not be able to be detected correctly though is set within the possible range.

	Over error Light level is too large. Do one of the following and then repeat the operation. • Adjust the Head to decrease the incident light level. • Execute power tuning.
	Lo error Light level is too small. Do one of the following and then repeat the operation. • Adjust the Head to increase the incident light level. • Execute power tuning.
	Near error The difference of incident light level is too small. Do one of the following and then repeat the operation. • Adjust the Head to increase the difference between the two incident light levels.

5. Detailed Settings

The following functions can be set in SET mode. The default settings are shown in the transition boxes between functions.

All settings except for the operation mode and timer settings are the same for both channels.

*: The values shown for thresholds, incident light levels, percentages, etc., are examples only. Actual displays may vary.

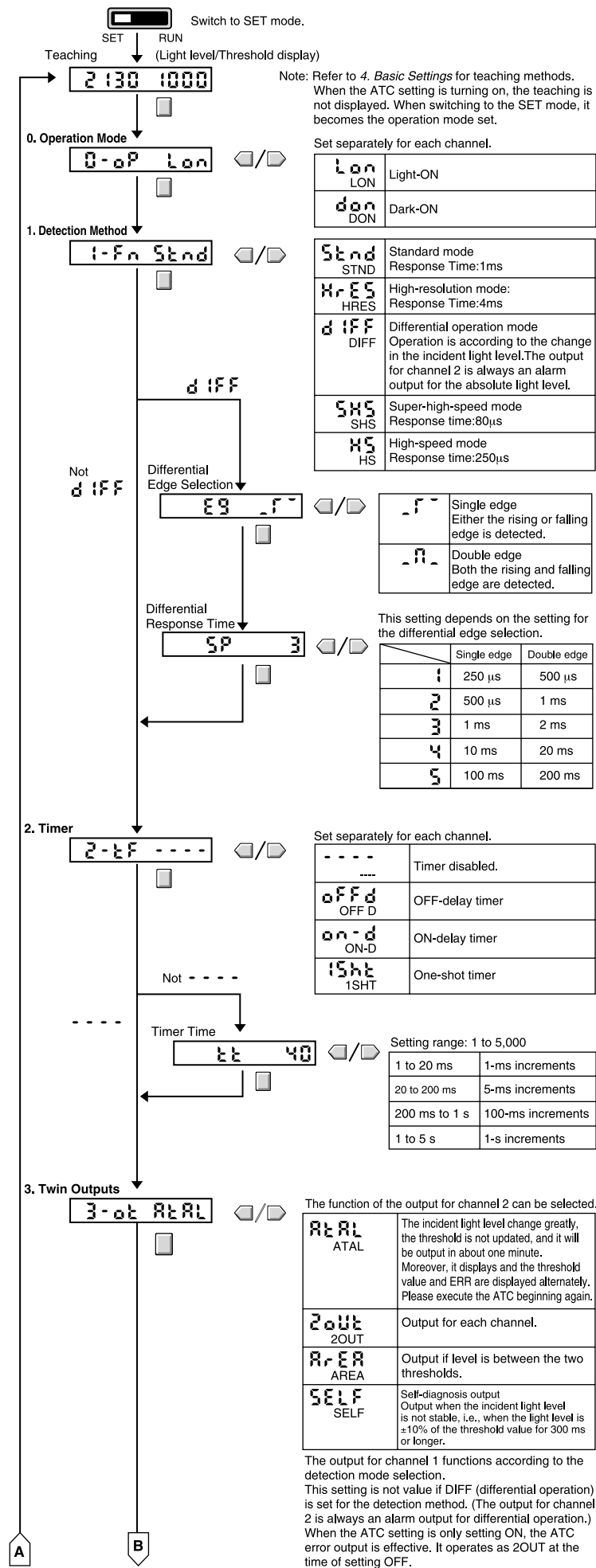

6. Convenient Functions

Zeroing the Main Display

The incident light level displayed on the main display can be zeroed. The threshold displayed in the sub-display is shifted by an amount corresponding to the amount the incident light level was changed.

Confirm that the MODE key setting is 0RST (zero reset) in advance. PTUN (power tuning) is the default setting. Refer to 5. Detailed Settings.

Zero-reset is not possible if the detection function is set to "DIFF" (differential operation).

Setting Method

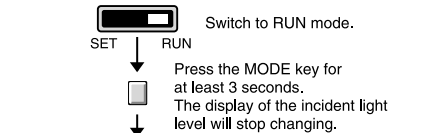

Clearing Method

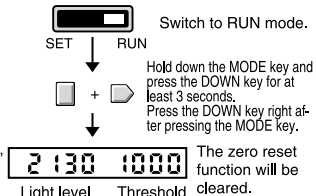

Key Lock

All key operations can be disabled to help prevent key operating errors. Only the operation keys are disabled. The switches and selectors will still function.

Setting Method

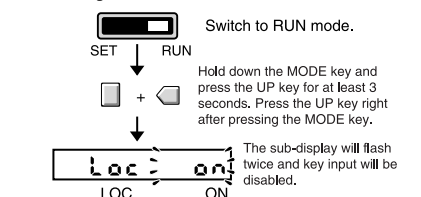

Clearing Method

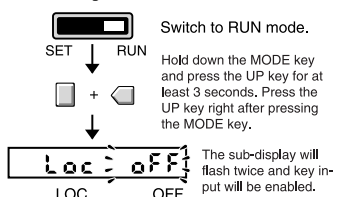

If a key is pressed while key operations are locked, "LOC ON" will flash twice on the display to indicate that key operations have been disabled.

LOC ON

Initializing Settings

This procedure can be used to return all the settings to the original default values.

Setting Method

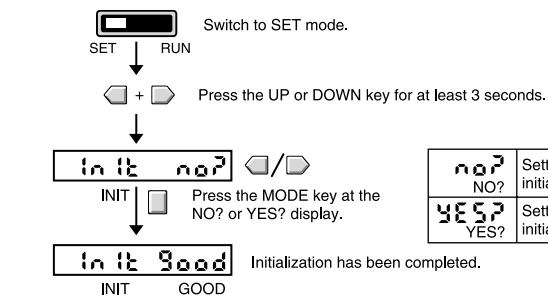

7. Installing the Amplifier Unit

Mounting Units

Catch the hook on the Fiber Unit connector end of the Unit on the DIN Track and then press down on the other end of the Unit until it locks into place.

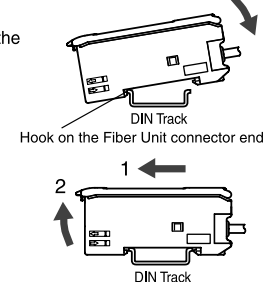

Always attach the Fiber Unit connector end first. If the incorrect end is attached first, the mounting strength will be reduced.

Removing Units

Press the Unit in the direction indicated by "1" and then lift up on the Fiber Unit connector end of the Unit in the direction indicated by "2."

Joining Amplifier Units (for Units with Connectors)

Up to 16 Units can be joined.

- Mount the Amplifier Units one at a time onto the DIN Track.
- Slide the Amplifier Units together and press the Amplifier Units together until they click into place.

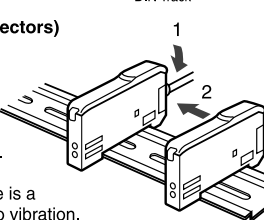

Secure the Units with an End Plate (PEP-M) if there is a possibility of the Amplifier Units moving, e.g., due to vibration.

Reverse the above procedure to separate and remove the Units. Do not attempt to remove Amplifier Units from the DIN Track without separating them first.

8. Connecting the Fiber Unit

- Open the protective cover
- Press up the lock button.
- Insert the fibers all the way to the back of the connector insertion opening.
- Return the lock button to its original position to secure the fibers.

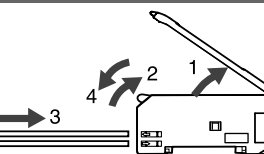

Reverse the above procedure to disconnect the Fiber Unit.

9. I/O Circuits

E3X-DA11AT-S and E3X-DA6AT-S

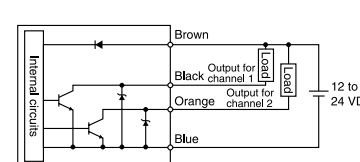

E3X-DA41AT-S and E3X-DA8AT-S

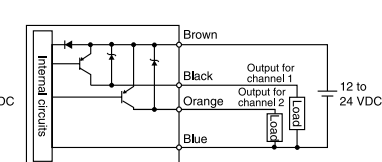

10. Dimensions

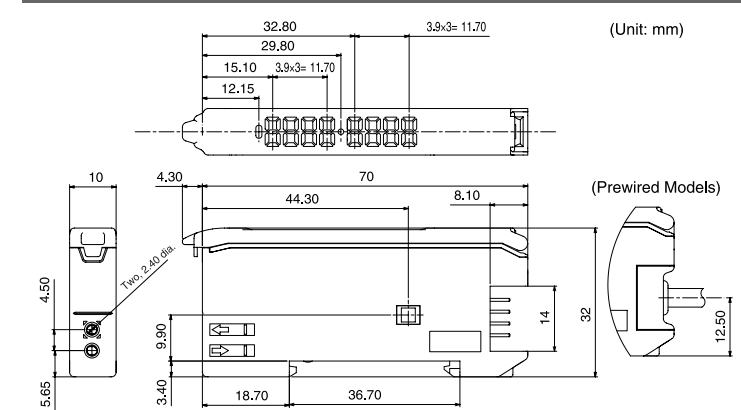

Suitability for Use

THE PRODUCTS CONTAINED IN THIS SHEET ARE NOT SAFETY RATED. THEY ARE NOT DESIGNED OR RATED FOR ENSURING SAFETY OF PERSONS, AND SHOULD NOT BE RELIED UPON AS A SAFETY COMPONENT OR PROTECTIVE DEVICE FOR SUCH PURPOSES. Please refer to separate catalogs for OMRON's safety rated products.

OMRON shall not be responsible for conformity with any standards, codes, or regulations that apply to the combination of the products in the customer's application or use of the product. Take all necessary steps to determine the suitability of the product for the systems, machines, and equipment with which it will be used. Know and observe all prohibitions of use applicable to this product.

NEVER USE THE PRODUCTS FOR AN APPLICATION INVOLVING SERIOUS RISK TO LIFE OR PROPERTY WITHOUT ENSURING THAT THE SYSTEM AS A WHOLE HAS BEEN DESIGNED TO ADDRESS THE RISKS, AND THAT THE OMRON PRODUCT IS PROPERLY RATED AND INSTALLED FOR THE INTENDED USE WITHIN THE OVERALL EQUIPMENT OR SYSTEM.

See also Product catalog for Warranty and Limitation of Liability.

■ EUROPEAN H.Q.
OMRON EUROPE B.V. Sensor Business Unit
Carl-Benz Str.4, D-71154 Nufringen Germany
Phone:49-7032-811-0 Fax: 49-7032-811-199

■ NORTH AMERICA
OMRON ELECTRONICS LLC
One Commerce Drive Schaumburg, IL60173-5302 U.S.A
Phone:1-847-843-7900 Telephone Consultation
1-800-55-OMRON Fax : 1-847-843-7787

■ Asia, Pacific
OMRON ASIA PACIFIC PTE LTD
83 Clemenceau Avenue, #11-01 UE Square, Singapore 239920
Phone : 65-6-835-3011 / Fax : 65-6-835-2711

OMRON Corporation