

Plastic Cylindrical Inductive Prox

E2F

Short Length, Shielded Sensors With Threaded Plastic Body

- Rugged, watertight plastic housing offers good chemical resistance and withstands washdown
- Wide operating voltages: 10 to 30 VDC and 20 to 264 VAC
- Operation indicator on all models
- Short-circuit protection available on all DC and some AC models

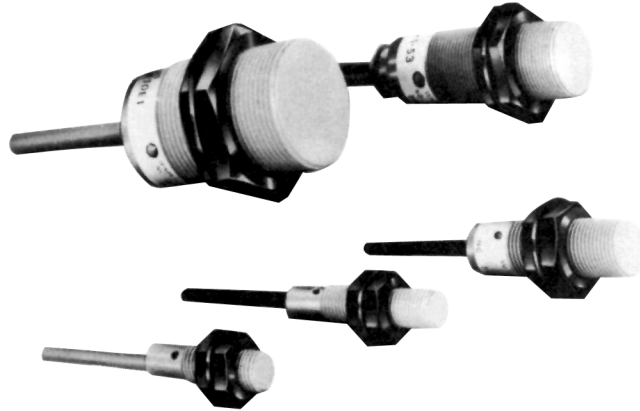

Ordering Information

■ DC THREE-WIRE PREWIRED MODELS

Type	Size	Sensing distance			Output configuration	Part number	
						NO	NC
Shielded 	M8		1.5 mm		NPN	E2F-X1R5E1	E2F-X1R5E2
					PNP	E2F-X1R5F1	E2F-X1R5F2
	M12		2 mm		NPN	E2F-X2E1	E2F-X2E2
					PNP	E2F-X2F1	E2F-X2F2
	M18		5 mm		NPN	E2F-X5E1	E2F-X5E2
					PNP	E2F-X5F1	E2F-X5F2
	M30		10 mm		NPN	E2F-X10E1	E2F-X10E2
					PNP	E2F-X10F1	E2F-X10F2

■ AC TWO-WIRE PREWIRED MODELS

Without Short-Circuit Protection

Type	Size	Sensing distance			Part number	
					NO	NC
Shielded 	M8		1.5 mm		E2F-X1R5Y1	E2F-X1R5Y2
	M12		2 mm		E2F-X2Y1	E2F-X2Y2
	M18		5 mm		E2F-X5Y1-US	E2F-X5Y2-US
	M30		10 mm		E2F-X10Y1-US	E2F-X10Y2-US

With Short-Circuit Protection

Type	Size	Sensing distance			Part number	
					NO	NC
Shielded 	M18		5 mm		E2F-X5Y1-53-US	E2F-X5Y2-53-US
	M30		10 mm		E2F-X10Y1-53-US	E2F-X10Y2-53-US

■ ACCESSORIES

Description		Part number
Mounting brackets	Fits M8 size sensors	Y92E-B8
	Fits M12 size sensors	Y92E-B12
	Fits M18 size sensors	Y92E-B18
	Fits M30 size sensors	Y92E-B30

■ REPLACEMENT PARTS

Description		Part number
Mounting hardware: one pair of plastic nuts	Fits M8 size sensors (supplied with each sensor)	M8-PHWS
	Fits M12 size sensors (supplied with each sensor)	M12-PHWS
	Fits M18 size sensors (supplied with each sensor)	M18-PHWS
	Fits M30 size sensors (supplied with each sensor)	M30-PHWS

Specifications

■ DC 3-WIRE MODELS

Part number		E2F-X1R5□□	E2F-X2□□	E2F-X5□□	E2F-X10□□
Sensor Type		Inductive			
Body	Size	M8	M12	M18	M30
	Type	Shielded			
Supply voltage		10 to 30 VDC			
Current consumption		17 mA max.			
Detectable object type		Metallic objects			
Effective maximum detecting distance (with standard target)		1.5 mm (0.06 in) ±15%	2 mm (0.08 in) ±10%	5 mm (0.20 in) ±10%	10 mm (0.39 in) ±10%
Usable detecting range (with standard target)		0 to 1.2 mm (0 to 0.05 in)	0 to 1.6 mm (0 to 0.06 in)	0 to 4 mm (0 to 0.16 in)	0 to 8 mm (0 to 0.31 in)
Standard target size (mild steel, L x W x H)		8 x 8 x 1 mm (0.31 x 0.31 x 0.04 in)	12 x 12 x 1 mm (0.47 x 0.47 x 0.04 in)	18 x 18 x 1 mm (0.71 x 0.71 x 0.04 in)	30 x 30 x 1 mm (1.18 x 1.18 x 0.04 in)
Differential travel		10% max. of effective max. detecting distance			
Control output	DC solid-state	Type	NPN-NO open collector with pull-up (E2F-X□□E1) NPN-NC open collector with pull-up (E2F-X□□E2) PNP-NO open collector with pull-down (E2F-X□□F1) PNP-NC open collector with pull-down (E2F-X□□F2)		
		Max. load	200 mA		
		Max. on-state voltage drop	2 VDC		
Response frequency		2 Hz	1.5 kHz	600 Hz	400 Hz
Circuit protection	Output short-circuit	Provided; automatic resetting type			
	DC power supply reverse polarity	Provided			
	Weld field immunity	Not provided			
	RFI immunity	Not provided			
Indicators		Target Present (red LED)			
Materials	Housing	Plastic			
	Sensing face	Plastic			
	Cable sheath	Plastic			
Mounting		Two plastic M8 nuts included. Bracket Y92E-B8 optional.	Two plastic M12 nuts included. Bracket Y92E-B12 optional.	Two plastic M18 nuts included. Bracket Y92E-B18 optional.	Two plastic M30 nuts included. Bracket Y92E-B30 optional.
Connections	Prewired	3-conductor cable, 2 m (6.56 ft) length			
Weight with cable		Approx. 40 g (1.4 oz)	Approx. 50 g (1.8 oz)	Approx. 130 g (4.6 oz)	Approx. 170 g (6.0 oz)
Enclosure ratings	UL	—			
	NEMA	---			
	IEC 144	IP67			
Approvals	UL	—			
	CSA	—			
Ambient operating temperature		-25°C to 70°C (-13° to 158°F)			
Vibration		10 to 55 Hz, 1.5 mm (0.06 in) double amplitude			
Shock		Approx. 100 G			

■ AC 2-WIRE MODELS

Part number		E2E2F-X1R5Y□	E2F-X2Y□	E2F-X5Y□-US E2F-X5Y□-53-US	E2F-X10Y□-US E2F-X10Y□-53-US	
Sensor Type		Inductive				
Body	Size	M8	M12	M18	M30	
	Type	Shielded				
Supply voltage		20 to 264 VDC, 50/60 Hz		20 to 264 VAC, 50/60 Hz (E2F-X□□Y□-US) 90 to 140 VAC, 50/60 Hz (E2F-X□□Y□-53-US)		
Current consumption		5 mA max.				
Detectable object type		Metallic objects				
Effective maximum detecting distance (with standard target)		1.5 mm (0.06 in) ±15%	2 mm (0.08 in) ±10%	5 mm (0.20 in) ±10%	10 mm (0.39 in) ±10%	
Usable detecting range (with standard target)		0 to 1.2 mm (0 to 0.05 in)	0 to 1.6 mm (0 to 0.06 in)	0 to 4 mm (0 to 0.16 in)	0 to 8 mm (0 to 0.31 in)	
Standard target size (mild steel, L x W x H)		8 x 8 x 1 mm (0.31 x 0.31 x 0.04 in)	12 x 12 x 1 mm (0.47 x 0.47 x 0.04 in)	18 x 18 x 1 mm (0.71 x 0.71 x 0.04 in)	30 x 30 x 1 mm (1.18 x 1.18 x 0.04 in)	
Differential travel		10% max. of effective max. detecting distance				
Control output	AC solid-state	Type	SCR-NO (E2F-X□□Y1-□□-□□) SCR-NC (E2F-X□□Y2-□□-□□)			
		Max. load	100 mA	300 mA for E2F-X□□Y□-US and E2F-X□□Y□-53-US at -25°C to 70°C (-13°F to 158°F) 500 mA for E2F-X□□Y□-US at -25°C to 55°C (-13°F to 131°F)		
		Min. load	5 mA			
		Max. off-state leakage current	1.7 mA at 200 VAC		1.7 mA at 200 VAC (E2F-X□□Y□-US) 1.5 mA at 200 VAC (E2F-X□□Y□-53-US)	
		Max. on-state voltage drop	See "Residual Load Voltage Characteristics" graph in <i>Engineering Data</i> .			
Response frequency		25 Hz				
Circuit protection	Output short-circuit	Not provided		Provided on E2F-X□□Y□-53-US types only; manual resetting type		
	Weld field immunity	Not provided				
	RFI immunity	Not provided				
Indicators		Output Operation (red LED)				
Materials	Housing	Polyarylate				
	Sensing face	Polyarylate				
	Cable sheath	Polyvinyl Chloride				
Mounting		Two plastic M8 nuts included. Bracket Y92E-B8 optional.	Two plastic M12 nuts included. Bracket Y92E-B12 optional.	Two plastic M18 nuts included. Bracket Y92E-B18 optional.	Two plastic M30 nuts included. Bracket Y92E-B30 optional.	
Connections	Prewired	2-conductor cable, 2 m (6.56 ft) length				
Weight with cable		Approx. 40 g (1.4 oz)	Approx. 50 g (1.8 oz)	Approx. 130 g (4.6 oz)	Approx. 170 g (6.0 oz)	
Enclosure ratings	UL	—		1		
	NEMA	---				
	IEC 144	IP67				
Approvals	UL	—		Recognized, File number E76675		
	CSA	—		Certified, File number LR45951		
Ambient operating temperature		-25°C to 70°C (-13° to 158°F)				
Vibration		10 to 55 Hz, 1.5 mm (0.06 in) double amplitude				
Shock		Approx. 100 G				

Operation

OUTPUT CIRCUIT DIAGRAM AND TIMING CHARTS

DC 3-Wire Models

NPN output

The dotted line shows a transistor circuit load.

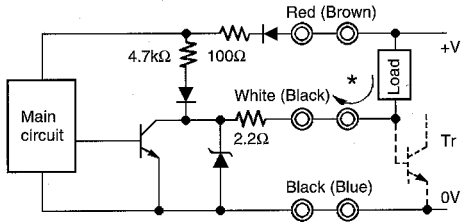

*200mA max. (sink current), 2V max. (residual voltage)

PNP output

The dotted line shows a transistor circuit load.

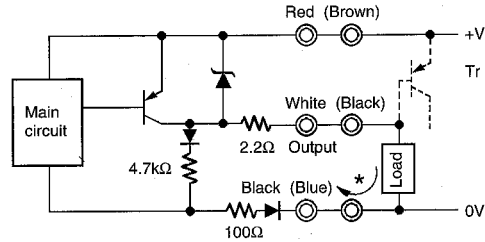

*200mA max. (source current), 2V max. (residual voltage)

Note: IEC colors are shown in parentheses.

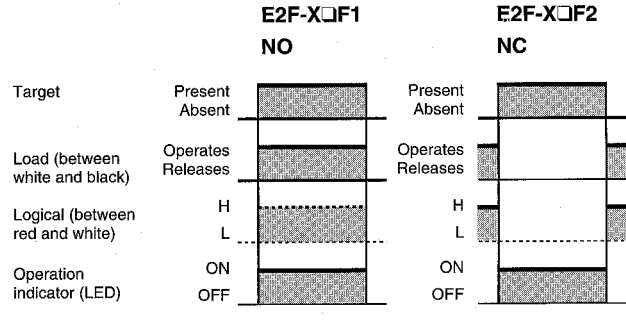
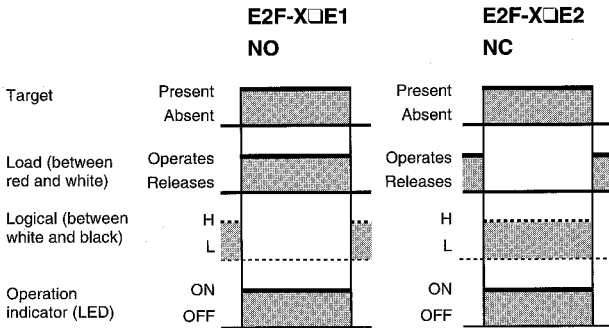

AC 2-Wire Models

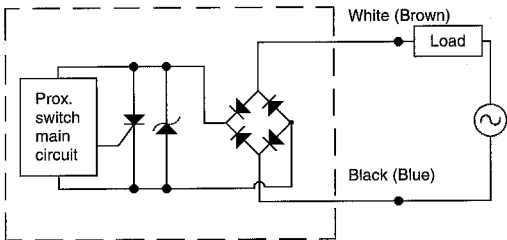

Note: IEC colors are shown in parentheses.

With Short-Circuit Protection

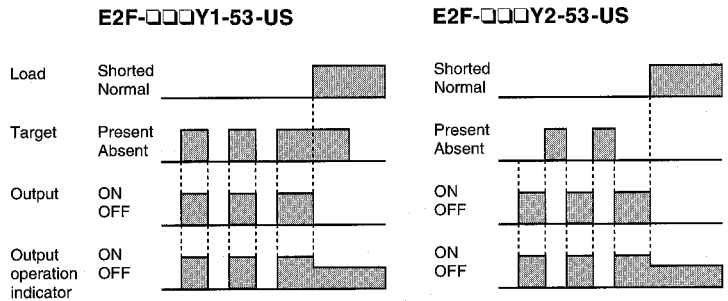

Without Short-Circuit Protection

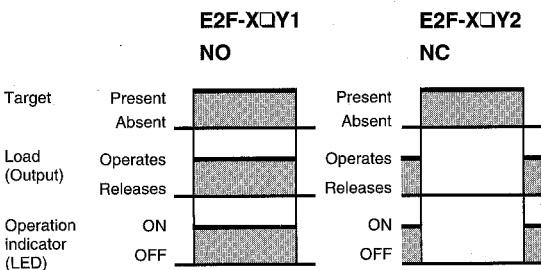

Short-Circuit Indication

The LED dims when the load is shorted, and the load output immediately turns off and remains off until the short-circuit protection is reset.

Resetting Short-Circuit Protection

Before the short-circuit protection can be reset, the short must be repaired. We recommend turning the power off before repairing the short. If this approach is taken, no further action is required to reset the short-circuit protection.

If the short must be repaired with power on, these additional steps are required:

For NO sensors, the target must be removed to reset the short-circuit protection.

For NC sensors, the target must be presented then removed to reset the short-circuit protection.

Engineering Data

Operating Range

Shielded M8 and M12 Size Sensors E2F-X1R5□□, E2F-X2□□

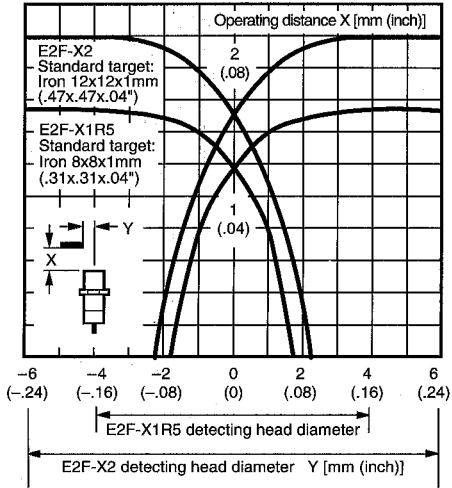

Shielded M18 and M30 Size Sensors E2F-X5□□, E2F-X10□□

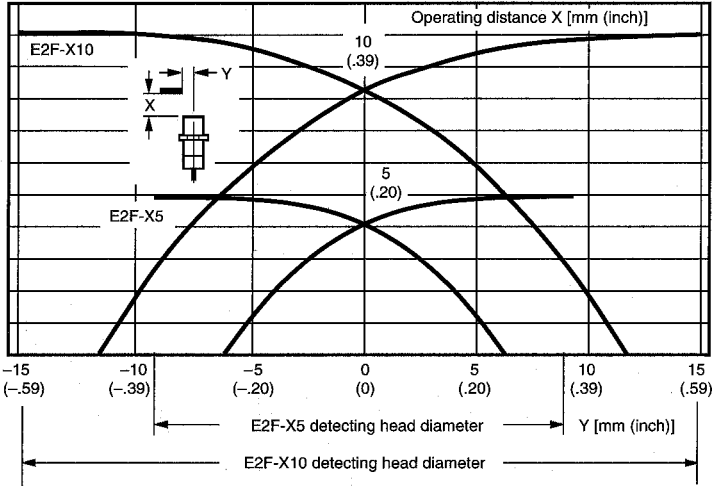

Detecting Distance vs. Size and Material of Target

Shielded M8 and M12 Size Sensors E2F-X1R5□□, E2F-X2□□

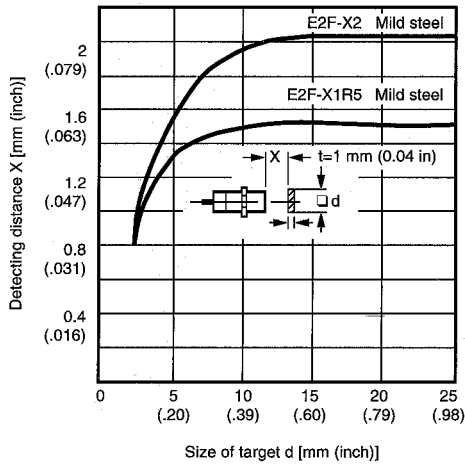

Shielded M18 and M30 Size Sensors E2F-X5□□, E2F-X10□□

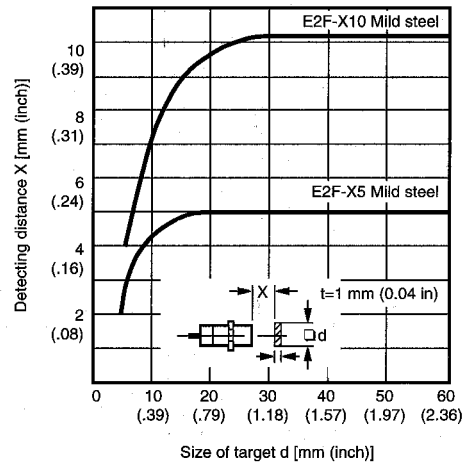

Note: If the target is a nonferrous metal, the operating distance of the proximity sensor decreases. However, with a piece of foil measuring about 0.01 mm (0.0004 in) in thickness, the detecting distance is equivalent to that with a ferrous metal. Note that the proximity sensor cannot detect extremely thin evaporated films and non-conductive targets.

Residual Load Voltage Characteristics

100 VAC

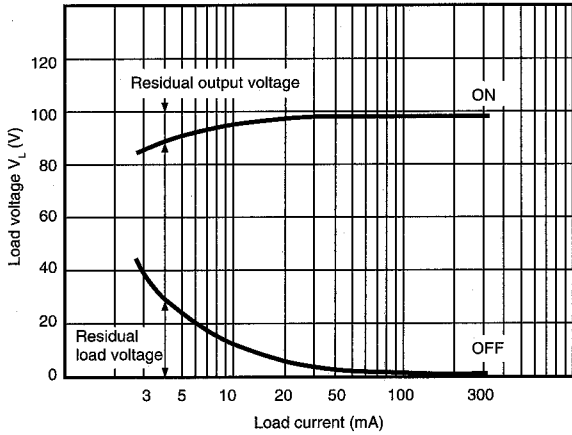

200 VAC

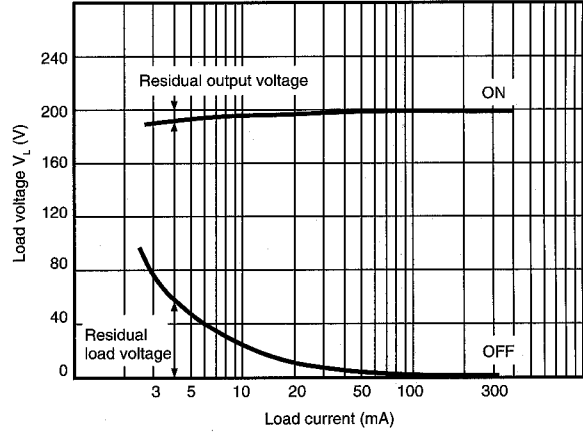

Note: If the load current is less than 5 mA, the residual voltage of the load increases when the proximity sensor is in the OFF state. In this case, connect a bleeder resistor in parallel with the load and allow a current of more than 5 mA to flow through the load. Use the formulas at right to calculate the power rating and value of the resistor.

$$R \leq \frac{Vs}{5 - i} \text{ (k}\Omega\text{)}$$

$$P > \frac{Vs^2}{R} \text{ (mW)}$$

P : Wattage of bleeder resistor
 i : Load current (mA)
 Vs: Supply voltage (V)

Leakage Current Characteristics

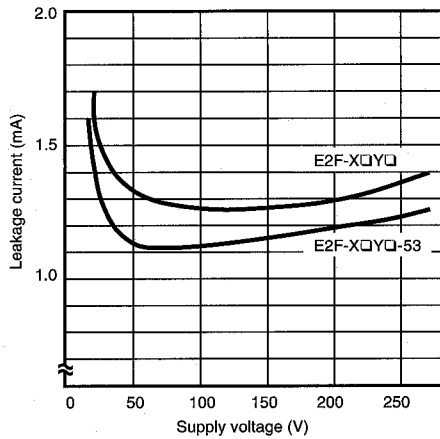

Dimensions

Unit: mm (inch)

■ SENSORS

DC 3-Wire Models

DC Shielded M8 Size E2F-X1R5E(F)□

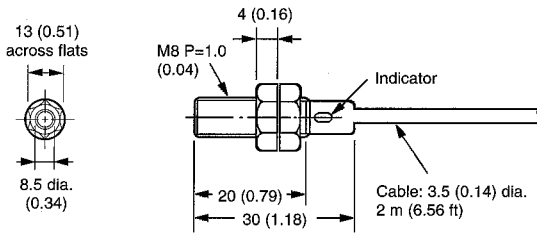

DC Shielded M12 Size E2F-X2E(F)□

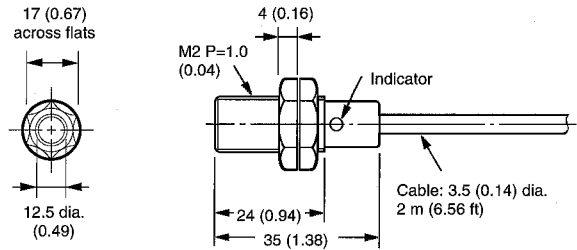

DC Shielded M18 Size E2F-X5E(F)□

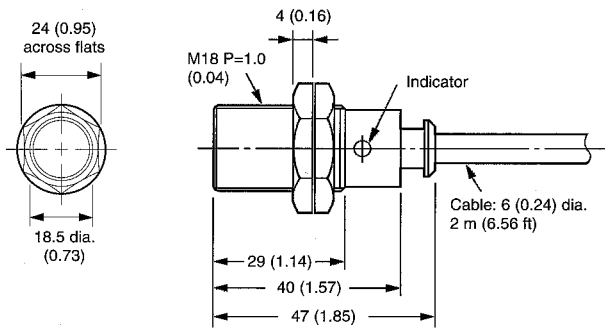

DC Shielded M30 Size E2F-X10E(F)□

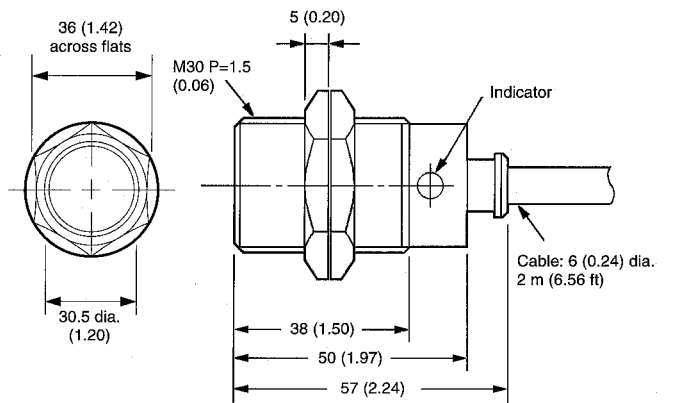

AC-2-Wire Models

AC Shielded M8 Size E2F-X1R5Y□

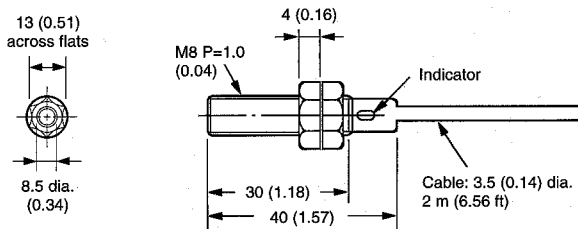

AC Shielded M12 Size E2F-X2Y□

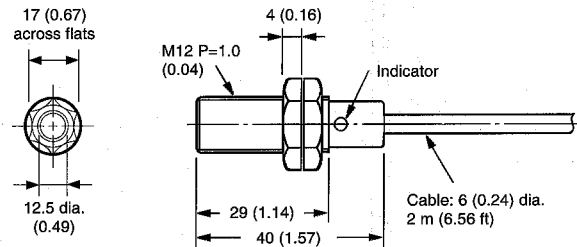

**AC Shielded M18 Size without
short-circuit protection
E2F-X5Y□-US**

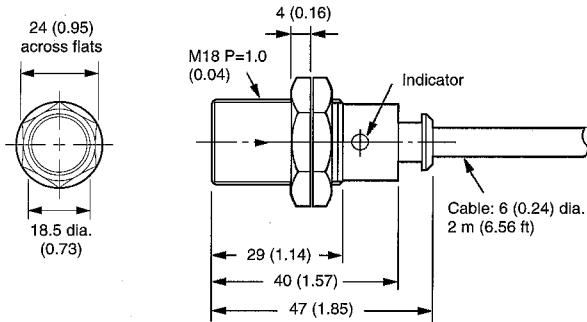

**AC Shielded M18 Size with
short-circuit protection
E2F-X5Y□-53-US**

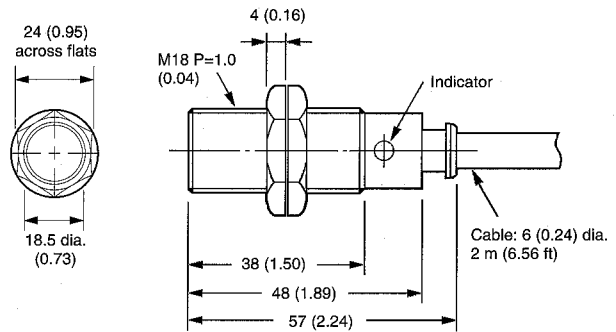

**AC Shielded M30 Size
E2F-X10Y□-US, E2F-X10Y□-53-US,**

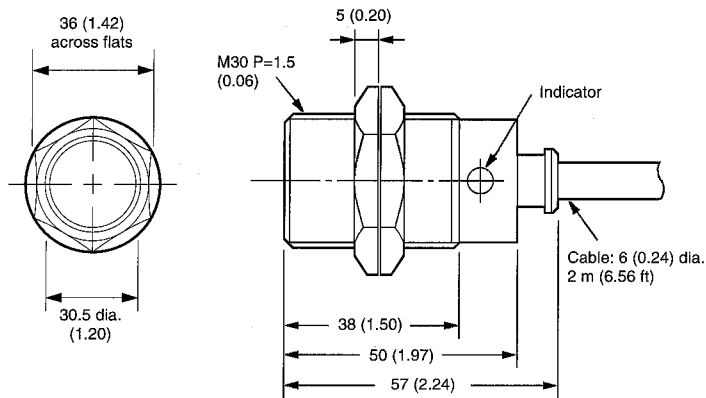

OPTIONAL MOUNTING BRACKETS

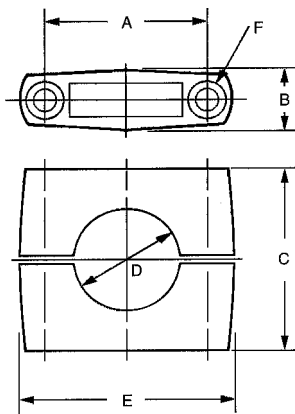

Part number	Drawing dimensions						Applicable sensor models
	A	B	C	D	E	F	
Y92E-B8	18 ±0.2 (0.71 ±0.01)	10 (0.39) max.	18 (0.71)	8 (0.31) dia.	28 (1.10) max.	M4 x 20 bolt	E2F-X1R5E(F)(Y)□
Y92E-B12	24 ±0.2 (0.94 ±0.01)	12.5 (0.49) max.	20 (0.79)	12 (0.47) dia.	37 (1.46) max.	M4 x 25 bolt	E2F-X2E(F)(Y)□
Y92E-B18	32 ±0.2 (1.26 ±0.01)	17 (0.67) max.	30 (1.18)	18 (0.71) dia.	47 (1.85) max.	M5 x 32 bolt	E2F-X5E(F)(Y)□-US, E2F-X5Y□-53-US
Y92E-B30	45 ±0.2 (1.77 ±0.01)	17 (0.67) max.	50 (1.97)	30 (1.18) dia.	60 (2.36) max.	M5 x 50 bolt	E2F-X10E(F)(Y)□-US, E2F-X10Y□-53-US

Precautions

■ TIGHTENING FORCE

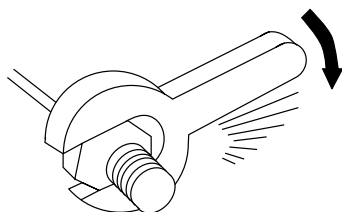

Do not exceed the torque listed in the table provided when tightening the mounting nuts.

Part number	Maximum torque	
	kg-cm	in-lbs
E2F-X1R5□□	8	6.93
E2F-X2□□	8	6.93
E2F-X5□□-(53)-US	20	17.32
E2F-X10□□-(53)-US	20	17.32

■ EFFECTS OF SURROUNDING METALS

When mounting a proximity sensor flush with a metallic panel, be sure to provide a minimum distance as shown in the table below. This prevents the sensor from being effected by metallic objects other than the target.

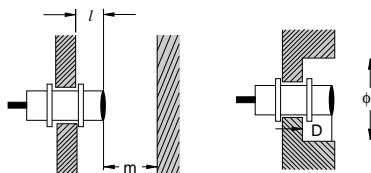

Drawing dimension	Sensor model							
	E2F-X1R5□□		E2F-X2□□		E2F-X5□□		E2F-X10□□	
	mm	inch	mm	inch	mm	inch	mm	inch
<i>l</i>	0	0	0	0	0	0	0	0
<i>d</i> (dia.)	8	0.31	12	0.47	18	0.71	30	1.18
<i>D</i>	0	0	0	0	0	0	0	0
<i>m</i>	4.5	0.18	8	0.31	20	0.79	40	1.57

■ MUTUAL INTERFERENCE

To prevent mutual interference between two sensors, be sure to space the two sensors at a distance greater than that shown in the table below.

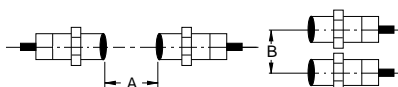

Drawing dimension	Sensor model							
	E2F-X1R5□□		E2F-X2□□		E2F-X5□□		E2F-X10□□	
	mm	inch	mm	inch	mm	inch	mm	inch
<i>A</i>	20	0.79	30	1.18	50	1.97	100	3.94
<i>B</i>	15	0.59	20	0.79	35	1.38	70	2.76

OMRON

OMRON ELECTRONICS LLC

One East Commerce Drive
Schaumburg, IL 60173

1-800-55-OMRON

OMRON ON-LINE

Global - <http://www.omron.com>
USA - <http://www.omron247.com>
Canada - <http://www.omron.ca>

OMRON CANADA, INC.

885 Milner Avenue
Scarborough, Ontario M1B 5V8
416-286-6465