

Color Sensing
Digital Fiber Sensor
E3X-DAC-S

OMRON

Easy and Reliable

The Fiber Sensor **That Sees in Color**

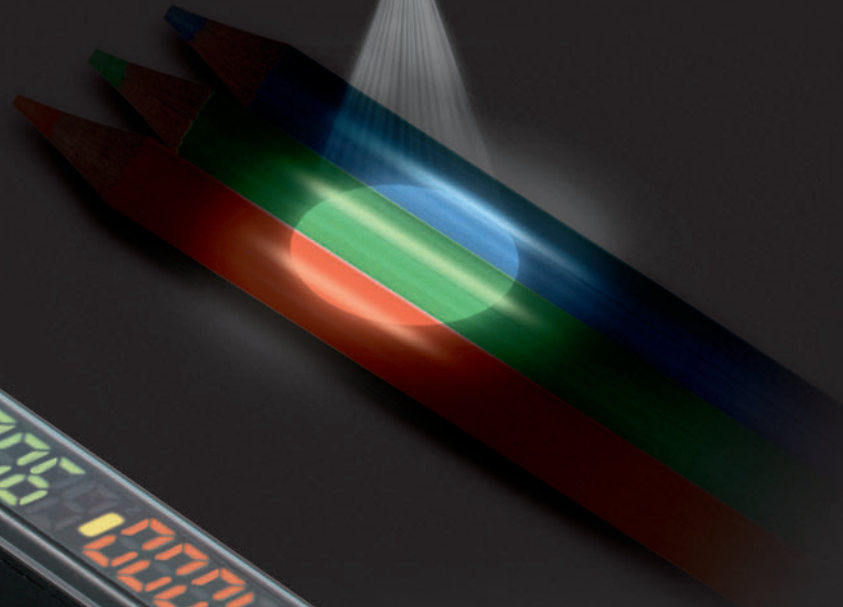

New Model with Four-color Determination for Even More Complete Color-sensing Fiber Sensors

realizing



Color Sensing

Color-Sensing Engine



Color Sensing

Easy and Reliable ... Featuring a Color-sensing Engine

The color-sensing engine uses three parameters, RGB, to process incident light. It detects color information from the workpiece for precise detection of color differences.

Precise Detection

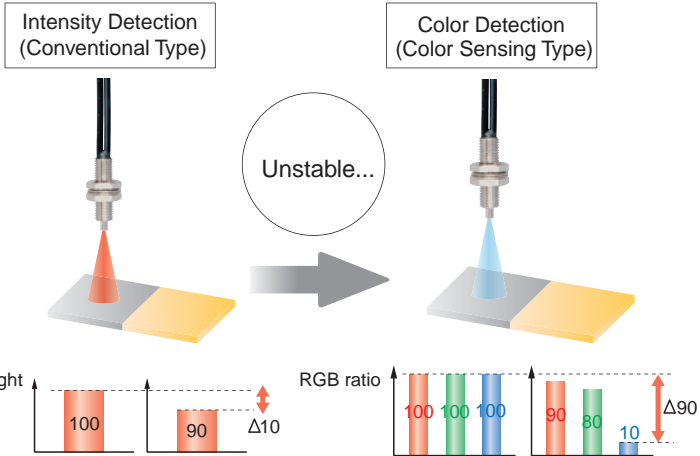

Color VS. Detection Capability

	White	Red	Yellow-red	Yellow	Yellow-green	Green	Blue-green	Blue	Blue-purple	Purple	Red-purple	Black
White	○	○	○	○	○	○	○	○	○	○	○	○
Red	○	○	○	○	○	○	○	○	○	○	○	○
Yellow-red	○	○	○	○	○	○	○	○	○	○	○	○
Yellow	○	○	○	○	○	○	○	○	○	○	○	○
Yellow-green	○	○	○	○	○	○	○	○	○	○	○	○
Green	○	○	○	○	○	○	○	○	○	○	○	○
Blue-green	○	○	○	○	○	○	○	○	○	○	○	○
Blue	○	○	○	○	○	○	○	○	○	○	○	○
Blue-purple	○	○	○	○	○	○	○	○	○	○	○	○
Purple	○	○	○	○	○	○	○	○	○	○	○	○
Red-purple	○	○	○	○	○	○	○	○	○	○	○	○
Black	○	○	○	○	○	○	○	○	○	○	○	○

A high-power white LED and a multi-RGB processing system combine to cover all RGB wavelengths, enabling easy and accurate detection of workpieces without having to use a different light source to match each one.

No Need to Select

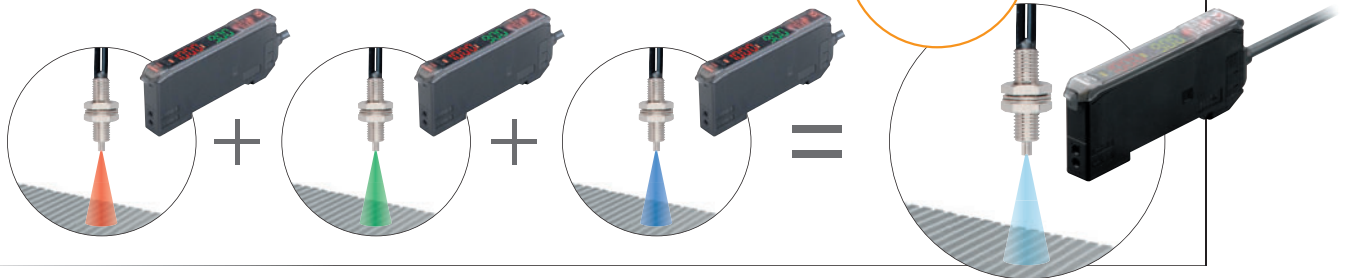

Changes in the three parameters are processed as a ratio, so they are not affected by light-intensity variations due to workpiece movement.

Resists Movement

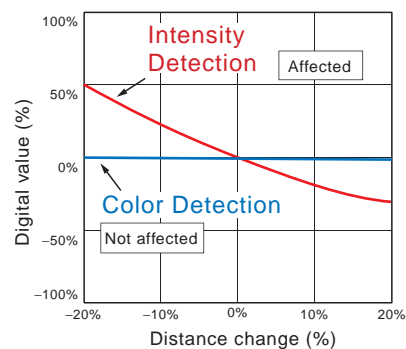
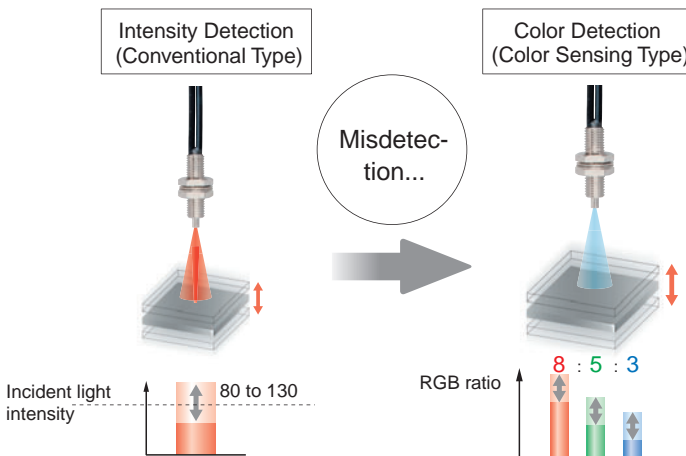

Amplifier Unit

Thinnest in the Industry

A Slim, 10-mm-wide Amplifier Unit

Use of a white LED and a one-package RGB light-receiving element has made it possible to unify the Amplifier Unit, both in size and operation, with conventional models. If detection should become unstable, the Amplifier Unit can be separately replaced to immediately regain stability.

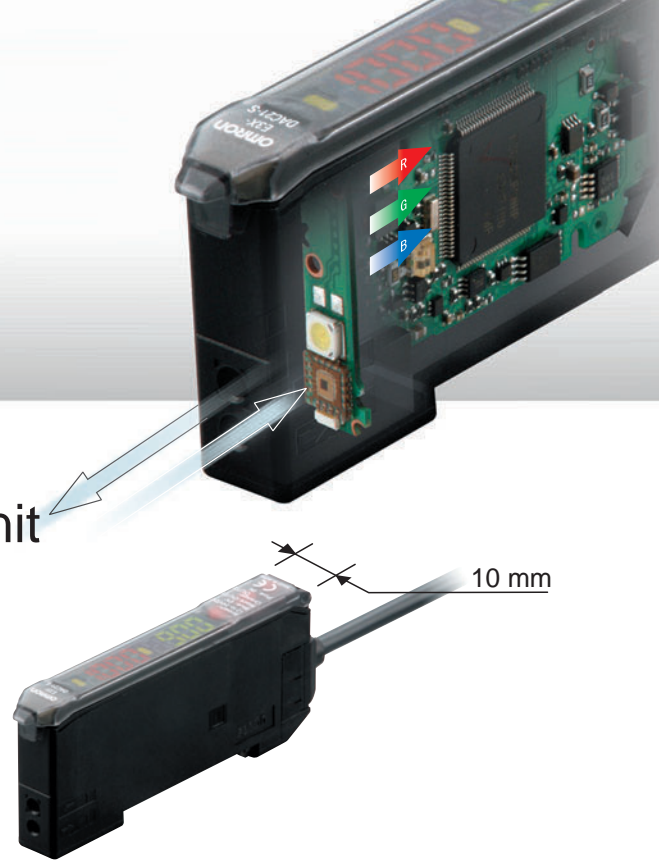

Easy and Reliable ... Ease of Use and Smart Functions

In addition to ensuring easy use, we have added a number of smart functions, such as remote control to simplify setup, and twin sensing and output to simultaneously distinguish two registered colors. (advanced models)

First in Its Class

This function guides the user to ensure that the workpiece is in an appropriate position for teaching. (Indicates OVER, OK, or LOW.)

Reliable

Setting guide function.



Easy to Understand

A double display for easy, precise setting.

One push is all it takes.

Easy Setting

Easy and Reliable ... Simplified Wiring Connector Reduces Work Steps

OMRON's unique simplified wiring connectors provide the power for each added Sensor. Up to 16 Units can be mounted, including a combination of Digital Fiber Sensors and other simplified wiring connector products such as Digital Laser Sensors.

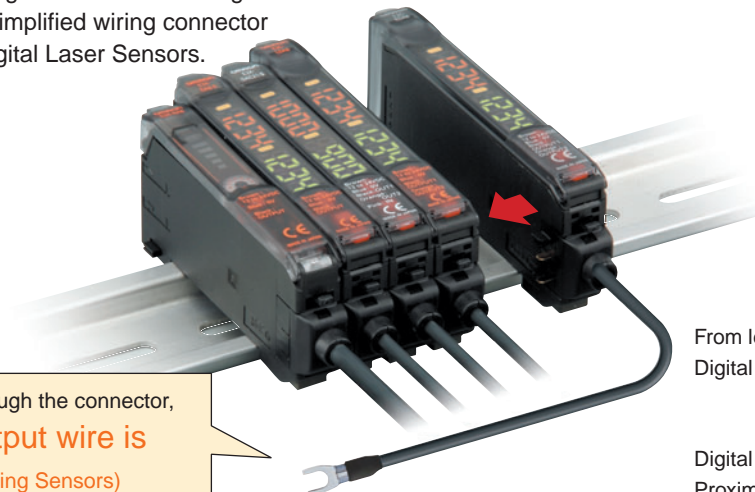

Power is supplied through the connector, so only one output wire is required. (For adding Sensors)

From left to right

- Digital Fiber Sensors: E3X-NA
E3X-DA-S/MDA
E3X-DAC-S
- Digital Laser Sensor: E3C-LDA
- Proximity Sensor: E2C-EDA

Application



Wide Range of Fiber Heads Available

Select from a wide range of Fiber Heads to match the workpiece and working space. This makes installation possible even in small spaces.

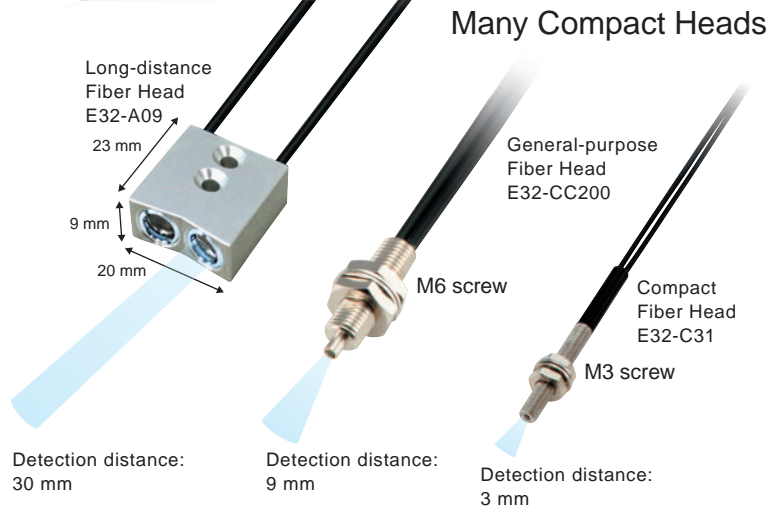

Easy and Reliable Applications (Examples)

Detecting Marks

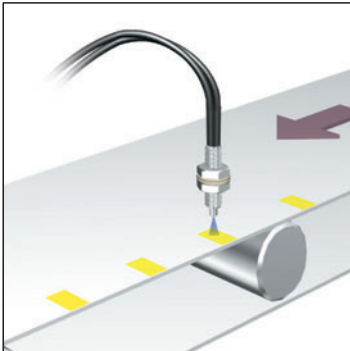

Because it distinguishes RGB ratios, detection is highly resistant to workpiece movement.

Distinguishing Semi-transparent Objects

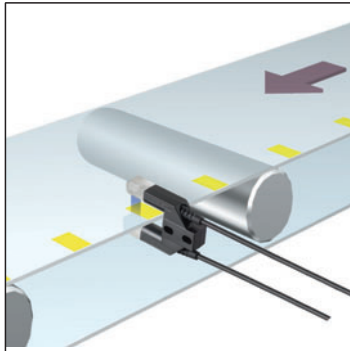

Through-beam Fiber Heads are capable of detecting color differences in semi-transparent objects.

Detecting Black Marks

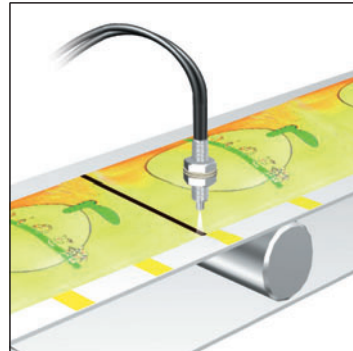

In Black Mode, black seam tape and other black marks can be detected regardless of film color or patterns.

Distinguishing Trays *

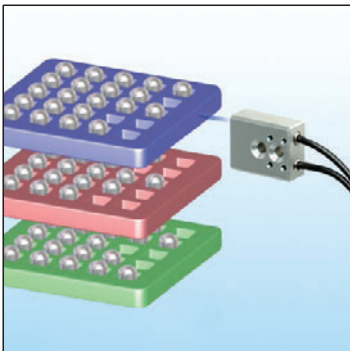

Four-color determination greatly reduces the work required for line switchovers.
* Switching banks requires 300 ms.

Detecting Wafers

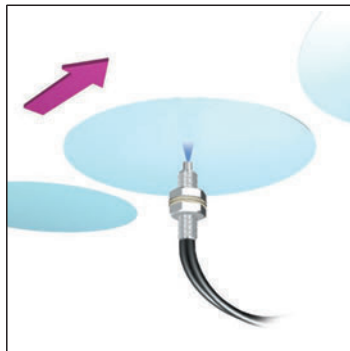

Workpieces that absorb a specific wavelength can be detected with a wide range of wavelengths.

Detecting Products on Conveyors

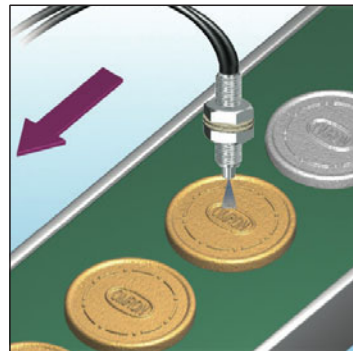

If you teach the conveyor (i.e., the background), you can detect workpieces even if they have different colors, shapes, or gloss.

Ordering Information

Amplifier Units

Pre-wired model (Standard cable length 2 m)

Item	Appearance	Functions	Model	
			NPN output	PNP output
Standard models		Timer, Response speed change	E3X-DAC11-S 2M	E3X-DAC41-S 2M
Advanced models (2-color simultaneous determination)		Standard models + Simultaneous determination (2 colors), AND/OR output, Remote setting	E3X-DAC21-S 2M	E3X-DAC51-S 2M
Advanced models (4-color determination*)		Standard models + Determination (4 colors), AND/OR output, bank switching	E3X-DAC21B-S 2M	E3X-DAC51B-S 2M

* Four-color determination is enabled by switching between banks for two outputs using an external input.

Amplifier Units with Connectors (Amplifier Unit Connectors must be purchased separately.)

Item	Appearance	Functions	Model	
			NPN output	PNP output
Standard models		Timer, Response speed change	E3X-DAC6-S	E3X-DAC8-S

Amplifier Unit Connectors (Order Separately) Note: Protector seals are provided as accessories.

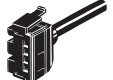
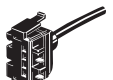
Item	Appearance	Cable length	No. of conductors	Model
Master Connector		2 m	3	E3X-CN11
Slave Connector			1	E3X-CN12

Combining Amplifier Units and Connectors

Amplifier Units and Connectors are sold separately. Refer to the following tables when placing an order.

Amplifier Unit	Applicable Connector (Order Separately)									
	Master Connector	Slave Connector								
<table border="1"> <thead> <tr> <th>Model</th> <th>NPN output</th> <th>PNP output</th> </tr> </thead> <tbody> <tr> <td>Standard models</td> <td>E3X-DAC6-S</td> <td>E3X-DAC8-S</td> </tr> </tbody> </table>	Model	NPN output	PNP output	Standard models	E3X-DAC6-S	E3X-DAC8-S	+	<table border="1"> <tbody> <tr> <td>E3X-CN11</td> <td>E3X-CN12</td> </tr> </tbody> </table>	E3X-CN11	E3X-CN12
Model	NPN output	PNP output								
Standard models	E3X-DAC6-S	E3X-DAC8-S								
E3X-CN11	E3X-CN12									

When Using 5 Amplifier Units

Amplifier Units (5 Units)	+	1 Master Connector	4 Slave Connectors
---------------------------	---	--------------------	--------------------

Accessories (Order Separately)

Mounting Bracket

Appearance	Model	Quantity
	E39-L143	1

End Plate

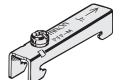
Appearance	Model	Quantity
	PFP-M	1

E3X-DAC-S

Ratings and Specifications

Amplifier Units

Type	Standard models	Advanced models (2-color simultaneous determination)	Advanced models (4-color determination)	
Item	Model	E3X-DAC□-S□ (□: 11/41/6/8)	E3X-DAC□-S□ (□: 21/51)	
Sensing distance	Depends on the Fiber Unit. Refer to pages 8 to 10.			
Sensing object	Reflective models: Standard 11 color cards (See note 1.), Through-beam models: Opaque or translucent object			
Light source (wavelength)	White LED (420 to 700 nm)			
Sensing method	C Mode: RGB ratio determination (or I Mode: Light intensity determination for red, green, or blue, Black Mode: Determination of total light intensity for red, green, and blue) (See note 2.)			
Number of registered colors	1	2 (simultaneous determination)	4 (2-color determination × 2 banks)	
Power supply voltage	12 to 24 VDC ±10%, ripple (p-p) 10% max.			
Power consumption	960 mW max. (current consumption: 40 mA max. at power supply voltage of 24 VDC)			
Control output	NPN or PNP open collector Load power supply voltage: 26.4 VDC max. Load current: 50 mA max. (residual voltage: 2 V max.)			
Number of control outputs	1 output	2 outputs		
External input (See note 3. (page 7))	---	Remote control	Bank switching	
Protection circuits	Reverse polarity for power supply connection, output short-circuit, Reversed output polarity protection			
Mutual interference prevention	Up to 10 Units (optical communications control)			
Response time	Super-high-speed mode (See note 4.)	Operate or reset: 60 μs	Operate or reset: 120 μs	
	High-speed mode	Operate or reset: 300 μs	Operate or reset: 600 μs	
	Standard mode	Operate or reset: 1 ms	Operate or reset: 2 ms	
	High-resolution mode	Operate or reset: 4 ms	Operate or reset: 8 ms	
Sensitivity setting (color registration, allowable range)	Teaching (one-point teaching or teaching with/without workpiece) or manual adjustment			
Functions	Operating mode	ON for match (ON for same color as registered color) or ON for mismatch (ON for different color from registered color)		
	Timer function	Timer type: OFF delay, ON delay, or one-short, Timer time: 1 ms to 5 s (variable)		
	Control outputs	---	Output for each channel, AND output, and OR output	
	Remote control	---	One-point teaching, teaching with/without workpiece, zero reset, and light emission OFF	Bank switching (Switching between banks A, B, C, and D.)
	Display switch (See note 5.)	Seven patterns total: Match + Threshold, Margin + Threshold, Analog bar display, Peak + Bottom, etc.		
	Initialization	Initial reset (factory defaults) or user reset (saved settings)		
	Zero-reset	Provided	Initial reset (factory default)	
Display	Operation indicator (orange)/ I mode display indicator (orange)	Channel 1 and channel 2 operation indicators (orange)		
Digital display	Seven-segment displays (Main display: Red, Sub-display: Green)			
Digital direction	Switchable between normal and reversed.			
Ambient illumination (Receiver side)	Incandescent lamp: 3,000 lux Sunlight: 10,000 lux			
Ambient temperature range (See note 6.)	Operating: -25°C to 55°C Storage: -30°C to 70°C (with no icing or condensation)			
Ambient humidity range	Operating and storage: 35% to 85% (with no condensation)			
Insulation resistance	20 MΩ min. (at 500 VDC)			
Dielectric strength	1,000 VAC at 50/60 Hz for 1 minute			
Vibration resistance	Destruction: 10 to 50 Hz with a 1.5-mm double amplitude for 2 hrs each in X, Y and Z directions			
Shock resistance	Destruction: 500 m/s ² , for 3 times each in X, Y and Z directions			
Degree of protection	IEC 60529 IP50 (with Protective Cover attached)			
Connection method	Pre-wired (Standard cable length 2 m) or Amplifier Unit connector (Units connected: 16 max.)	Pre-wired (Standard cable length 2 m)		

Note: Refer to page 7 for notes 1 to 6.

Type		Standard models	Advanced models (2-color simultaneous determination)	Advanced models (4-color determination)
Item	Model	E3X-DAC□-S□ (□: 11/41/6/8)	E3X-DAC□-S□ (□: 21/51)	E3X-DAC□B-S□ (□: 21/51)
Weight (packed state)		Pre-wired model: Approx. 100 g, Amplifier unit connector model: Approx. 55 g		
Materials	Case	Polybutylene terephthalate (PBT)		
	Cover	Polycarbonate (PC)		
Accessories		Instruction manual		

Note:1. Sensing Object: Standard Color Card (230 Colors) from Japan Color Enterprise Co., Ltd.)

Color (11 standard colors)	Munsell color notation
White	N9.5
Red	4R 4.5/12.0
Yellow/red	4YR 6.0/11.5
Yellow	5Y 8.5/11.0
Yellow/green	3GY 6.5/10.0
Green	3G 6.5/9.0
Blue/green	5BG 4.5/10.0
Blue	3PB 5.0/10.0
Blue/purple	9PB 5.0/10.0
Purple	7P 5.0/10.0
Red/purple	6RP 4.5/12.5
Black	(N2.0)

2. When teaching with/without a workpiece, the best sensing method will be automatically selected (RGB ratio (C Mode) or light intensity determination (I Mode)). If color differences are not strong enough and RGB ratios would result in unstable detection, then light intensity determination (I Mode) will be selected.

The detection mode can also be set to C, I, or Black Mode.

3. Input Specifications

	Contact input (relay or switch)	Non-contact input (transistor)
NPN	ON: Shorted to 0 V (sourcing current: 1 mA max.). OFF: Open or shorted to Vcc.	ON: 1.5 V max. (sourcing current: 1 mA max.) OFF: Vcc - 1.5 V to Vcc (leakage current: 0.1 mA max.)
	ON: Shorted to Vcc (sinking current: 3 mA max.). OFF: Open or shorted to 0 V.	ON: Vcc - 1.5 V to Vcc (sinking current: 3 mA max.) OFF: 1.5 V max. (leakage current: 0.1 mA max.)

Refer to the *Instruction Manual* for the external input pulse width. A pulse width of 300 ms or longer is required to switch banks for the E3X-DAC□B-S.

- Mutual interference prevention cannot be used in super-high-speed mode, and light intensity determination (I Mode) must be used.
- With light intensity determination (I Mode), the correlation is not displayed, but rather the light intensity is displayed.
- The allowable ambient operating temperature changes according to the number of Units that are linked.
2 Units: -25 to 55°C, 3 to 10 Units: -25 to 50°C, and 11 to 16 Units: -25 to 45°C

Amplifier Unit Connectors

Item	Model	E3X-CN11	E3X-CN12
Rated current		2.5 A	
Rated voltage		50 V	
Contact resistance		20 mΩ max. (20 mVDC max., 100 mA max.) (The figure is for connection to the Amplifier Unit and the adjacent Connector. It does not include the conductor resistance of the cable.)	
No. of insertions		Destruction: 50 times (The figure for the number of insertions is for connection to the Amplifier Unit and the adjacent Connector.)	
Materials	Housing	Polybutylene terephthalate (PBT)	
	Contacts	Phosphor bronze/gold-plated nickel	
Weight (packed state)		Approx. 55 g	Approx. 25 g

E3X-DAC-S

Sensing Distance

Threaded Models

Through-beam Fiber Units

Sensing direction	Size	Model	Sensing distance (mm)							
			Opaque object				(Translucent object) *			
			High-resolution mode	Standard mode	High-speed mode	Super-high-speed mode	High-resolution mode	Standard mode	High-speed mode	Super-high-speed mode
Right-angle	M4	E32-T11N 2M	150	110	95	50	30	22	18	16
Straight		E32-T11R 2M								

* These sensing distances are recommended to make the most of the detection capabilities of the Sensor.

Reflective Fiber Units

Sensing direction	Size	Model	Sensing distance (mm)							
			White paper				Standard color card (11 colors) (mutual determination)			
			High-resolution mode	Standard mode	High-speed mode	Super-high-speed mode	High-resolution mode	Standard mode	High-speed mode	Super-high-speed mode
Right-angle	M3	E32-C31N 2M	7.7	6	4.8	2.1	1.6	1.2	0.9	0.7
	M6	E32-C11N 2M	35	26	22	9	7.5	5	4.5	3
Straight	M3	E32-C31 2M	17	13	11	4.5	3.7	2.7	2.2	1.5
	M6	E32-D11R 2M	42	32	26	11	8.5	6	5	3.5
		E32-CC200 2M	60	45	35	16	12	9	7	4

Cylindrical Models

Through-beam Fiber Units

Size	Sensing direction	Model	Sensing distance (mm)							
			Opaque object				(Translucent object) *			
			High-resolution mode	Standard mode	High-speed mode	Super-high-speed mode	High-resolution mode	Standard mode	High-speed mode	Super-high-speed mode
1.5 dia.	Top-view	E32-T22B 2M	70	55	48	40	15	11	9	6
3 dia.		E32-T12R 2M	150	110	95	50	30	22	18	16
		Side-view	E32-T14LR 2M	55	44	38	19	12	8.5	7

* These sensing distances are recommended to make the most of the detection capabilities of the Sensor.

Reflective Fiber Units

Size	Sensing direction	Model	Sensing distance (mm)							
			White paper				Standard color card (11 colors) (mutual determination)			
			High-resolution mode	Standard mode	High-speed mode	Super-high-speed mode	High-resolution mode	Standard mode	High-speed mode	Super-high-speed mode
1.5 dia.	Top-view	E32-D22B 2M	8.8	6.7	5.8	2.1	1.8	1.3	1.1	0.7
3 dia.		E32-D221B 2M	19	15	13	4.5	4.1	3	2.4	1.5
		E32-D32L 2M	35	26	22	9	7.5	5	4.5	3

Flat Models

Through-beam Fiber Units

Sensing direction	Model	Sensing distance (mm)							
		Opaque object				(Translucent object) *			
		High-resolution mode	Standard mode	High-speed mode	Super-high-speed mode	High-resolution mode	Standard mode	High-speed mode	Super-high-speed mode
Top-view	E32-T15XR 2M	150	110	95	50	30	22	18	16
Side-view	E32-T15YR 2M	55	44	38	19	12	8.5	7	6.5
Flat-view	E32-T15ZR 2M								

* These sensing distances are recommended to make the most of the detection capabilities of the Sensor.

Reflective Fiber Units

Sensing direction	Model	Sensing distance (mm)							
		White paper				Standard color card (11 colors) (mutual determination)			
		High-resolution mode	Standard mode	High-speed mode	Super-high-speed mode	High-resolution mode	Standard mode	High-speed mode	Super-high-speed mode
Top-view	E32-D15XR 2M	42	32	26	11	8.5	6	5	3.5
Side-view	E32-D15YR 2M	10	7.5	6.5	2.5	2.1	1.5	1.3	0.9
Flat-view	E32-D15ZR 2M								

Sleeve Models

Through-beam Fiber Units

Sensing direction	Model	Sensing distance (mm)							
		Opaque object				(Translucent object) *			
		High-resolution mode	Standard mode	High-speed mode	Super-high-speedmode	High-resolution mode	Standard mode	High-speed mode	Super-high-speedmode
Top-view	E32-TC200BR 2M	150	110	95	50	30	22	18	16

* These sensing distances are recommended to make the most of the detection capabilities of the Sensor.

Reflective Fiber Units

Sensing direction	Model	Sensing distance (mm)							
		White paper				Standard color card (11 colors) (mutual determination)			
		High-resolution mode	Standard mode	High-speed mode	Super-high-speedmode	High-resolution mode	Standard mode	High-speed mode	Super-high-speedmode
Top-view	E32-DC200BR 2M	42	32	26	11	8.5	6	5	3.5

Small-spot, Reflective Sensors

Spot diameter	Center distance (mm)	Model	Sensing distance (mm)							
			White paper				Standard color card (11 colors) (mutual determination)			
			High-resolution mode	Standard mode	High-speed mode	Super-high-speedmode	High-resolution mode	Standard mode	High-speed mode	Super-high-speedmode
6 dia.	50	E32-L15 2M	40 to 80	40 to 80	40 to 80	40 to 80	40 to 55 *	40 to 55 *	–	–

* The distance to differentiate between blue and blue-purple is 43 to 53 mm.

High-power Beam

Through-beam Fiber Units

Sensing direction	Aperture angle	Model	Sensing distance (mm)							
			Opaque object				(Translucent object) *			
			High-resolution mode	Standard mode	High-speed mode	Super-high-speedmode	High-resolution mode	Standard mode	High-speed mode	Super-high-speedmode
Top-view	10 °	E32-T17L 10M	4,300	3,200	2,800	1,400	900	600	500	460
Side-view	30 °	E32-T14 2M	950	700	600	300	200	140	120	100
Right-angle	12 °	E32-T11N 2M + E39-F1	1,000	750	650	340	220	150	130	110
Top-view	12 °	E32-T11R 2M + E39-F1	1,000	750	650	340	220	150	130	110
Side-view	60 °	E32-T11R 2M + E39-F2	110	85	70	36	22	16	14	12
Top-view	12 °	E32-T11 2M + E39-F1	1,000	750	650	320	200	150	120	110
Side-view	60 °	E32-T11 2M + E39-F2	180	140	120	60	38	28	22	20
Top-view	12 °	E32-T61-S 2M + E39-F1	950	700	600	320	200	140	120	100
Side-view	60 °	E32-T61-S 2M + E39-F2	120	95	80	42	26	19	16	14

* These sensing distances are recommended to make the most of the detection capabilities of the Sensor.

Narrow View

Through-beam Fiber Units

Sensing direction	Aperture angle	Model	Sensing distance (mm)							
			Opaque object				(Translucent object) *			
			High-resolution mode	Standard mode	High-speed mode	Super-high-speedmode	High-resolution mode	Standard mode	High-speed mode	Super-high-speedmode
Side-view	4 °	E32-T24S 2M	360	280	240	120	75	55	46	40
		E32-T22S 2M	500	400	350	170	110	80	65	55

* These sensing distances are recommended to make the most of the detection capabilities of the Sensor.

E3X-DAC-S

Chemical-resistant, Oil-resistant Through-beam Fiber Units

Type	Sensing direction	Model	Sensing distance (mm)							
			Opaque object				(Translucent object) *			
			High-resolution mode	Standard mode	High-speed mode	Super-high-speed mode	High-resolution mode	Standard mode	High-speed mode	Super-high-speed mode
Chemical/oil-resistant	Top-view	E32-T12F 2M	850	650	550	280	180	120	100	95
	Side-view	E32-T11F 2M	550	420	360	180	110	80	70	60
		E32-T14F 2M	100	80	70	35	22	16	13	12
Chemical/oil-resistant at 150°C	Top-view	E32-T51F 2M	380	300	250	130	80	55	48	44

* These sensing distances are recommended to make the most of the detection capabilities of the Sensor.

Reflective Fiber Units

Type	Sensing direction	Model	Sensing distance (mm)							
			White paper				Standard color card (11 colors) (mutual determination)			
			High-resolution mode	Standard mode	High-speed mode	Super-high-speed mode	High-resolution mode	Standard mode	High-speed mode	Super-high-speed mode
Chemical/oil-resistant	Top-view	E32-D12F 2M	22	17	15	6	4.9	3.5	2.9	2
Chemical-resistant cable		E32-D11U 2M	42	32	26	11	8.5	6	5	3.5

Bending-resistant

Through-beam Fiber Units

Size	Model	Sensing distance (mm)							
		Opaque object				(Translucent object) *			
		High-resolution mode	Standard mode	High-speed mode	Super-high-speed mode	High-resolution mode	Standard mode	High-speed mode	Super-high-speed mode
1.5 dia.	E32-T22B 2M	70	55	48	40	15	11	9	6
M3	E32-T21 2M								
M4	E32-T11 2M	190	140	120	60	40	28	24	20
Square	E32-T25XB 2M	55	42	36	30	11	8	7	4.5

* These sensing distances are recommended to make the most of the detection capabilities of the Sensor.

Reflective Fiber Units

Size	Model	Sensing distance (mm)							
		White paper				Standard color card (11 colors) (mutual determination)			
		High-resolution mode	Standard mode	High-speed mode	Super-high-speed mode	High-resolution mode	Standard mode	High-speed mode	Super-high-speed mode
1.5 dia.	E32-D22B 2M	8.8	6.7	5.8	2.1	1.8	1.3	1.1	0.7
M3	E32-D21 2M								
3 dia.	E32-D221B 2M	19	15	13	4.5	4.1	3	2.4	1.5
M4	E32-D21B 2M								
M6	E32-D11 2M	42	32	26	11	8.5	6	5	3.5
Square	E32-D25XB 2M	14	10	9	3	3	2.1	1.7	1.1

Heat-resistant

Through-beam Fiber Units

Heat-resistant temperature	Model	Sensing distance (mm)							
		Opaque object				(Translucent object) *			
		High-resolution mode	Standard mode	High-speed mode	Super-high-speed mode	High-resolution mode	Standard mode	High-speed mode	Super-high-speed mode
150°C	E32-T51 2M	200	160	140	70	44	32	26	22
200°C	E32-T81R-S 2M	75	60	50	26	16	11	9.5	8.5
350°C	E32-T61-S 2M	120	95	80	42	26	19	16	14

* These sensing distances are recommended to make the most of the detection capabilities of the Sensor.

Reflective Fiber Units

Heat-resistant temperature	Model	Sensing distance (mm)							
		White paper				Standard color card (11 colors) (mutual determination)			
		High-resolution mode	Standard mode	High-speed mode	Super-high-speed mode	High-resolution mode	Standard mode	High-speed mode	Super-high-speed mode
150°C	E32-D51 2M	55	42	36	14	11	8.5	7	4.5
200°C	E32-D81R-S 2M	20	15	13	5	4	3	2.5	1.5
350°C	E32-D61-S 2M								
400°C	E32-D73-S 2M	13	10	8.5	3.5	2.8	2	1.7	1.2

Area Beam

Through-beam Fiber Units

Type	Sensing width	Model	Sensing distance (mm)							
			Opaque object				(Translucent object) *			
			High-resolution mode	Standard mode	High-speed mode	Super-high-speedmode	High-resolution mode	Standard mode	High-speed mode	Super-high-speedmode
Area	11 mm	E32-T16PR 2M	240	180	150	80	50	36	30	26
		E32-T16JR 2M	200	160	130	65	44	30	26	22
	30 mm	E32-T16WR 2M	360	280	240	120	75	55	46	40

* These sensing distances are recommended to make the most of the detection capabilities of the Sensor.

Reflective Fiber Units

Type	Sensing width	Model	Sensing distance (mm)							
			White paper				Standard color card (11 colors) (mutual determination)			
			High-resolution mode	Standard mode	High-speed mode	Super-high-speedmode	High-resolution mode	Standard mode	High-speed mode	Super-high-speedmode
Array	11 mm	E32-D36P1 2M	35	26	22	9	7.5	5	4.5	3

Vacuum-resistant

Through-beam Fiber Units

Heat-resistant temperature	Model	Sensing distance (mm)							
		Opaque object				(Translucent object) *			
		High-resolution mode	Standard mode	High-speed mode	Super-high-speedmode	High-resolution mode	Standard mode	High-speed mode	Super-high-speedmode
120°C	E32-T51V 1M	55	42	36	18	11	8.5	7	6
	E32-T51V 1M + E39-F1V	280	200	180	90	55	42	35	30
200°C	E32-T84SV 1M	130	100	85	45	28	20	17	15

* These sensing distances are recommended to make the most of the detection capabilities of the Sensor.

E3X-DAC-S

Engineering Data (Reference Value)

Color vs. Detection Capability

E3X-DAC□-S+E32-CC200

	White	Red	Yellow/red	Yellow	Yellow/green	Green	Blue/green	Blue	Blue/purple	Purple	Red/purple	Black*
White		○	○	○	○	○	○	○	○	○	○	○
Red	○		○	○	○	○	○	○	○	○	○	○
Yellow/red	○	○		○	○	○	○	○	○	○	○	○
Yellow	○	○	○		○	○	○	○	○	○	○	○
Yellow/green	○	○	○	○		○	○	○	○	○	○	○
Green	○	○	○	○	○		○	○	○	○	○	○
Blue/green	○	○	○	○	○	○		○	○	○	○	○
Blue	○	○	○	○	○	○	○		○	○	○	○
Blue/purple	○	○	○	○	○	○	○	○		○	○	○
Purple	○	○	○	○	○	○	○	○	○		○	○
Red/purple	○	○	○	○	○	○	○	○	○	○		○
Black*	○	○	○	○	○	○	○	○	○	○	○	

Sensing distance: 9 mm (i.e., the teaching distance)

○: Detection possible, ×: Detection not possible.

* Use 2-point teaching to distinguish between white and black.

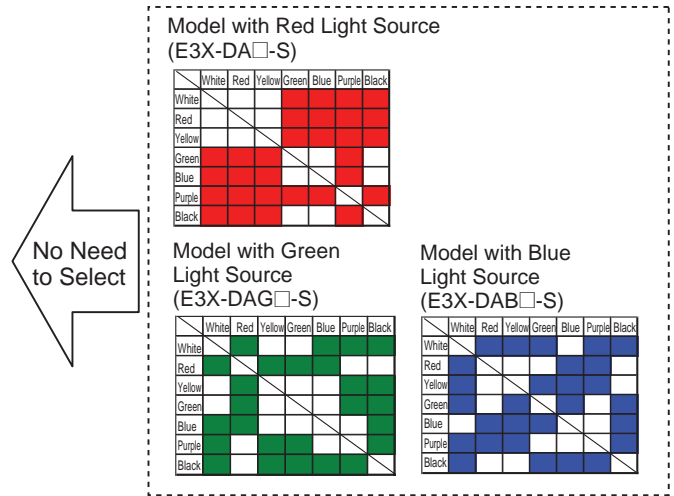

Color Detection Characteristics

E3X-DAC□-S+E32-CC200

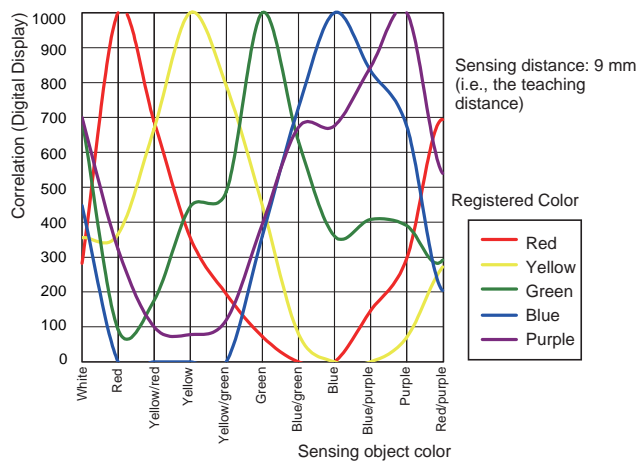

Color Detection Capability vs. Distance

E3X-DA□-S+E32-CC200

E3X-DAB/G□-S+E32-CC200 (Model with single-color light source)

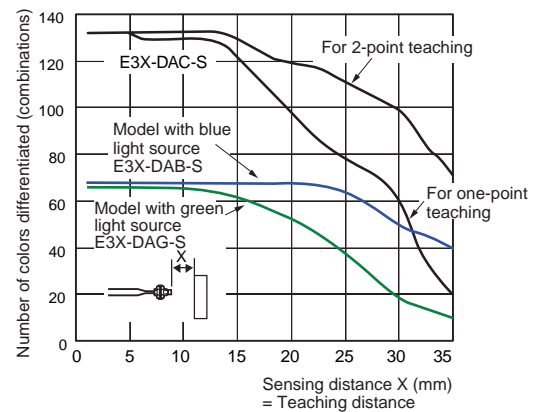

Correlation vs. Distance

E3X-DAC□-S+E32-CC200

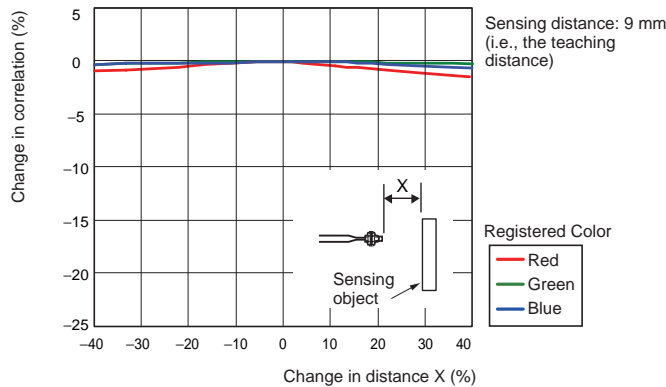

Correlation vs. Angle

E3X-DAC□-S+E32-CC200

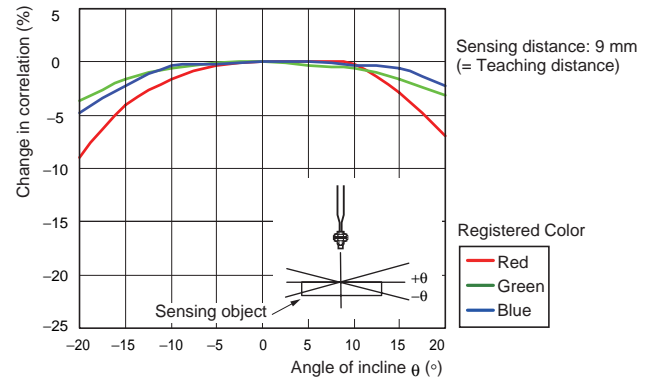

Output Circuit Diagrams

NPN Output

Model	Operation mode	Timing charts	Operation selector	Output circuit
E3X-DAC11-S E3X-DAC6-S	ON for match		LIGHT ON (L-ON)	
	ON for mismatch		DARK ON (D-ON)	
E3X-DAC21-S E3X-DAC21B-S	ON for match		LIGHT ON (L-ON)	
	ON for mismatch		DARK ON (D-ON)	

PNP Output

Model	Operation mode	Timing charts	Operation selector	Output circuit
E3X-DAC41-S E3X-DAC8-S	ON for match		LIGHT ON (L-ON)	
	ON for mismatch		DARK ON (D-ON)	
E3X-DAC51-S E3X-DAC51B-S	ON for match		LIGHT ON (L-ON)	
	ON for mismatch		DARK ON (D-ON)	

Note: 1. Timing Charts for Timer Function Settings (T: Set Time)

ON delay	OFF delay	One-shot

2. Control Output (AND, OR, Sync) and Timing Chart for Timer Settings (T: Set Time)

CH1 ON	CH1 ON
CH1 OFF	CH1 OFF
CH2 ON	CH2 ON
CH2 OFF	CH2 OFF
OUT ON (AND)	ON delay ON
OUT OFF (AND)	OFF delay ON
OUT ON (OR)	One-shot ON
OUT OFF (OR)	One-shot OFF

E3X-DAC-S

Nomenclature

Amplifier Units

Standard Models

E3X-DAC□-S (□: 11/41/6/8)

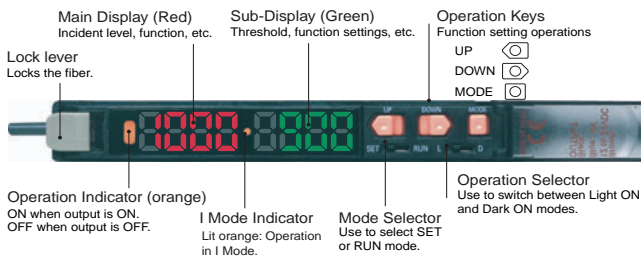

Advanced Models (2-color simultaneous determination, 4-color determination)

E3X-DAC□-S (□: 21/51), E3X-DAC□B-S (□: 21/51)

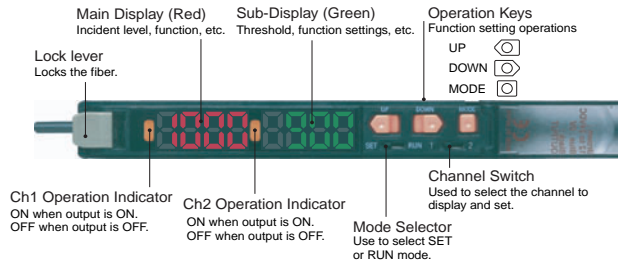

Safety Precautions

⚠ WARNING

This product is not designed or rated for ensuring safety of persons either directly or indirectly.

Do not use it for such purposes.



⚠ CAUTION

Do not use the product with voltage in excess of the rated voltage. Excess voltage may result in malfunction or fire.

Never use the product with an AC power supply. Otherwise, explosion may result.

High-temperature environments may result in burn injury.



Precautions for Safe Use

The following precautions must be observed to ensure safe operation of the Sensor.

1. Do not use the Sensor in an environment where explosive or flammable gas is present.
2. Do not use the Sensor in a location subject to splattering of water, oils, or chemicals.
3. Do not attempt to disassemble, repair, or modify the Sensor.
4. Do not apply voltages or currents that exceed the rated range to the Sensor.
5. Do not use the Sensor in an ambient atmosphere or environment that exceeds the ratings.
6. Wire the power supply correctly, including the polarity.
7. Connect the load correctly.
8. Do not short-circuit the load at both ends.
9. Do not use the Sensor if the case is damaged.
10. Dispose of the Sensor as industrial waste.
11. Do not use the Sensor in locations subject to direct sunlight.
12. Burn injury may occur. The Sensor surface temperature rises depending on application conditions, such as the ambient temperature and the power supply voltage. Use caution when operating or performing maintenance on the Sensor.

Precautions for Correct Use

Do not use the product in atmospheres or environments that exceed product ratings.

Amplifier Unit

● Designing

Operation after Turning Power ON

The Sensor is ready to detect within 200 ms after the power supply is turned ON. If the Sensor and load are connected to separate power supplies, be sure to turn ON the Sensor first. Time may be required for the degree of coincidence to stabilize after the power supply is turned ON.

Operation When Turning Power OFF

Output pulses may occur when the power is turned OFF. Turn OFF the power supply to the load and the load line before turning OFF the power supply to the Sensor.

● Mounting

Connecting and Disconnecting Connectors

Mounting Connectors

1. Insert the Master or Slave Connector into the Amplifier Unit until it clicks into place.

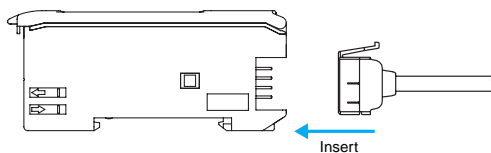

2. Attach the protector seals (provided as accessories) to the sides of master and slave connectors that are not connected.

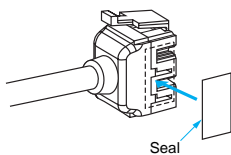

Note: Attach the seals to the sides with grooves.

Removing Connectors

1. Slide the slave Amplifier Unit(s) for which the Connector is to be removed away from the rest of the group.
2. After the Amplifier Unit(s) has been separated, press down on the lever on the Connector and remove it. (Do not attempt to remove Connectors without separating them from other Amplifier Units first.)

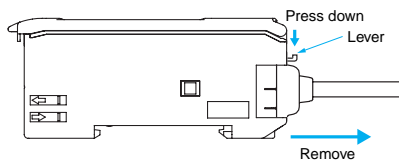

Adding and Removing Amplifier Units

Adding Amplifier Units

1. Mount the Amplifier Units one at a time onto the DIN track.

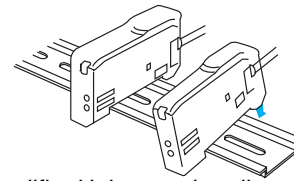

2. Slide the Amplifier Units together, line up the clips, and press the Amplifier Units together until they click into place.

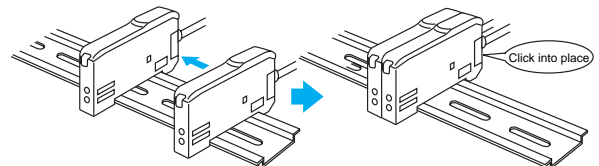

Removing Amplifier Units

Slide Amplifier Units away from each other, and remove from the DIN track one at a time. (Do not attempt to remove Amplifier Units from the DIN track without separating them first.)

Note: 1. The specifications for ambient temperature will vary according to the number of Amplifier Units used together. For details, refer to *Ratings and Specifications*.
2. Always turn OFF the power supply before joining or separating Amplifier Units.

Mounting the End Plate (PFP-M)

An End Plate should be used if there is a possibility of the Amplifier Unit moving, e.g., due to vibration.

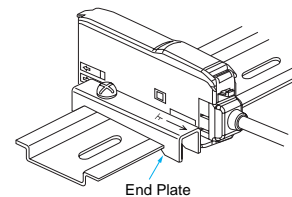

Fiber Connection

The E3X Amplifier Unit has a lock button for easy connection of the Fiber Unit. Connect or disconnect the fibers using the following procedures:

1. Connection

Open the protective cover, insert the fibers according to the fiber insertion marks on the side of the Amplifier Unit, and lower the lock lever.

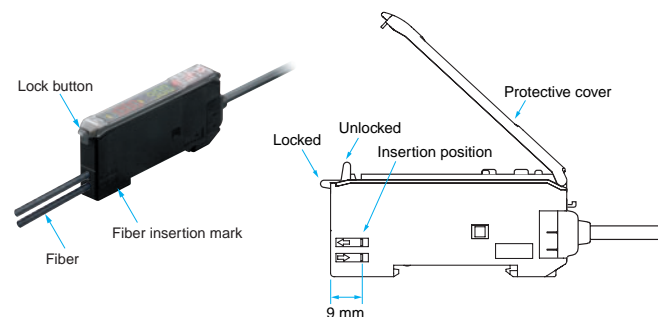

Note: Do not pull on, compress, or otherwise exert excessive force on the fibers after connecting them to the Amplifier Unit. (Do not exert more than 0.3 N·m.)

E3X-DAC-S

2. Disconnecting Fibers

Remove the protective cover and raise the lock lever to pull out the fibers.

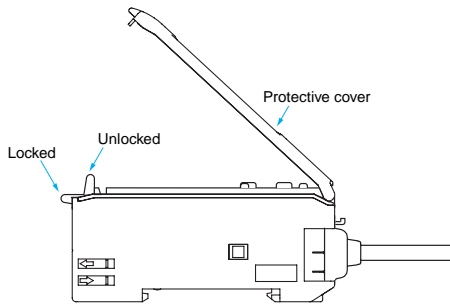

Note: 1. To maintain the fiber properties, confirm that the lock is released before removing the fibers.
2. Be sure to lock or unlock the lock button within an ambient temperature range between -10°C and 40°C .

● Adjusting

Mutual Interference Protection Function

Light from other sensors can cause the value on the digital display to become somewhat unstable. If this occurs, reduce the threshold to create a greater margin and enable more stable detection.

Output Short-circuit Protection

If the output short-circuit protection function operates because the load connected to the control output is short-circuited, OVER/CUR will flash on the display. Check the connection of the load.

EEPROM Writing Error

If the data is not written to the EEPROM correctly due to a power failure or static-electric noise, initialize the settings with the keys on the Amplifier Unit. ERR/EEP will flash on the display when a writing error has occurred.

Optical Communications

Several Amplifier Units can be slid together and used in groups. Do not, however, slide the Amplifier Units or attempt to remove any of the Amplifier Units during operation.

● Others

Protective Cover

Always keep the protective cover in place when using the Amplifier Unit.

Fiber Unit

● Design Precautions

Applicable Fiber Units

Refer to the sensing distance tables on pages 8 to 11 for the Fiber Units that can be used and the sensing distances. Retro-reflective, Limited-reflective, Ultra-compact, and Application-specific Fiber Units, which are not listed, cannot be used.

● Installation Precautions

Glossy Sensing Objects

If the sensing object is glossy, detection may not be stable. If the Sensor is inclined by 5° to 20° when using a glossy sensing object, as shown below, detection capabilities can be increased and stable detection achieved.

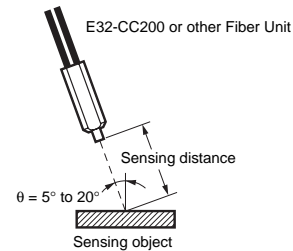

Dimensions

Amplifier Units

Amplifier Units with Cables

- E3X-DAC11-S
- E3X-DAC41-S
- E3X-DAC21-S
- E3X-DAC51-S
- E3X-DAC21B-S
- E3X-DAC51B-S

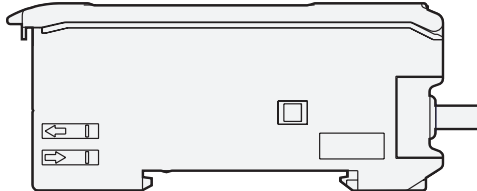
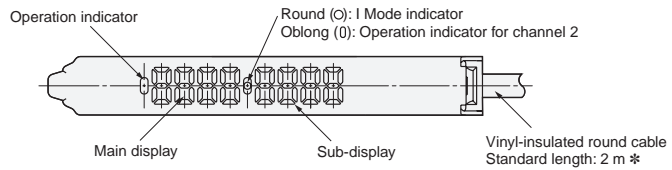

* Cable Specifications

E3X-DAC11-S -DAC41-S	4-dia., 3-conductor (Conductor cross section: 0.2 mm ² , insulator diameter: 1.1 mm)
E3X-DAC21-S -DAC51-S -DAC21B-S -DAC51B-S	4-dia., 5-conductor (Conductor cross section: 0.2 mm ² , insulator diameter, 1.1 mm)



With Mounting Bracket Attached

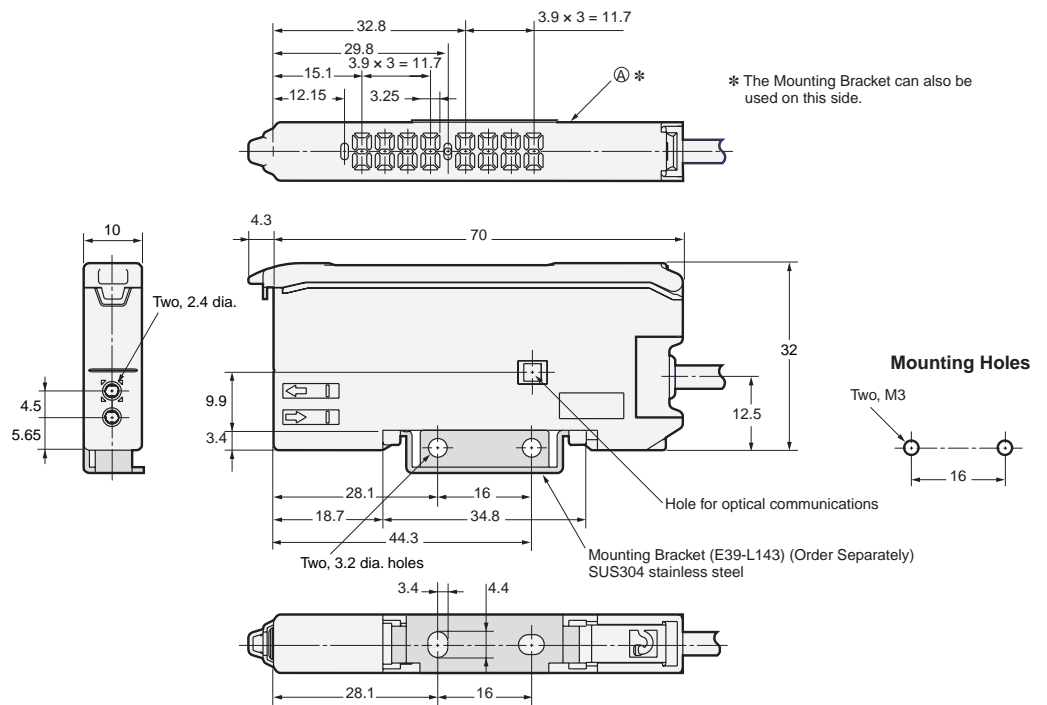

E3X-DAC-S

Amplifier Units with Connectors

E3X-DAC6-S
E3X-DAC8-S

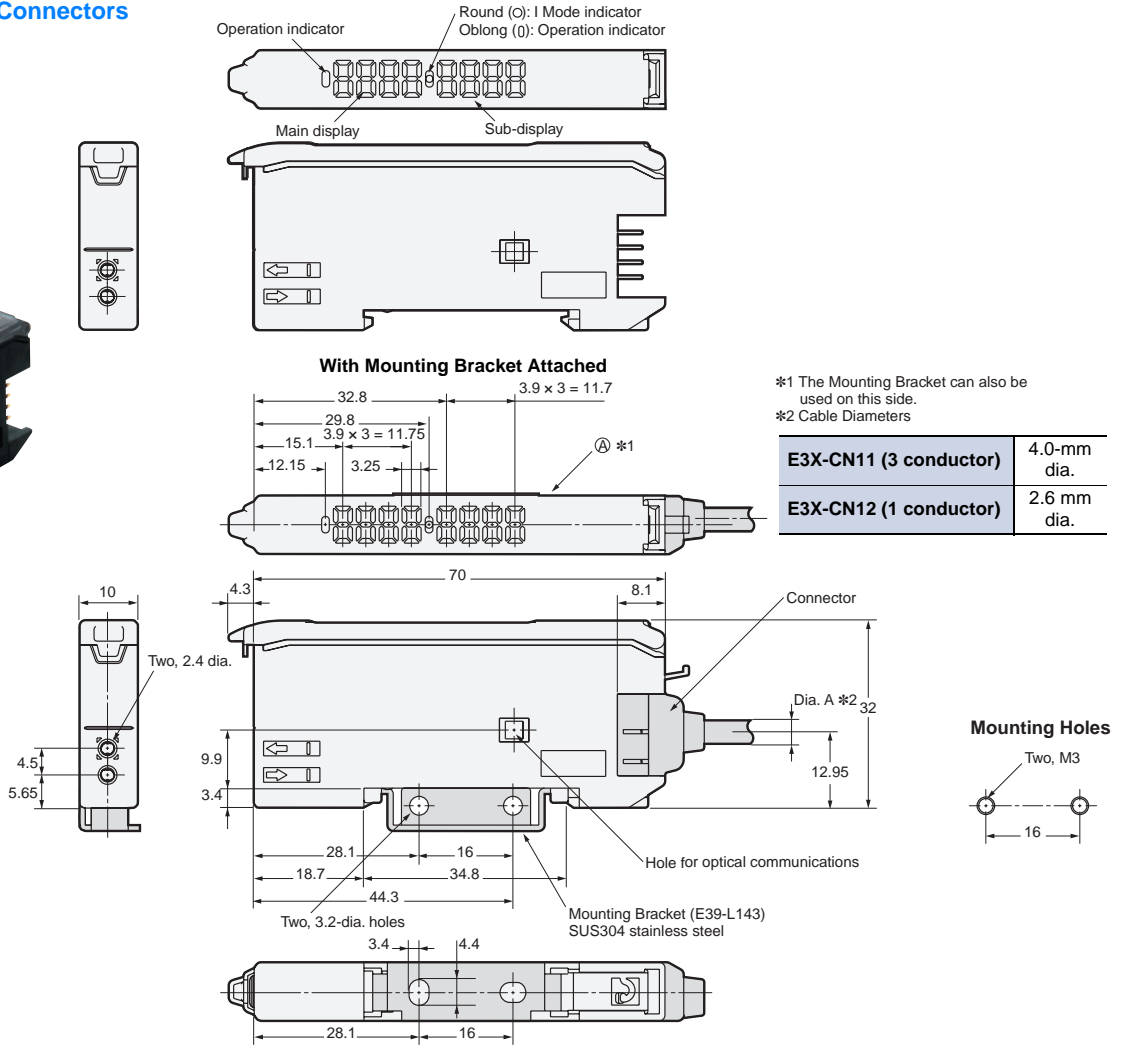

Amplifier Unit Connectors

Master Connectors
E3X-CN11

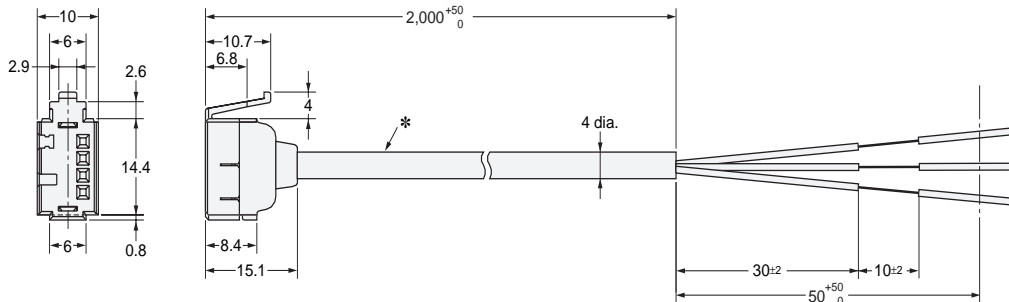
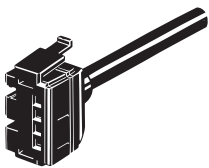

Slave Connectors
E3X-CN12

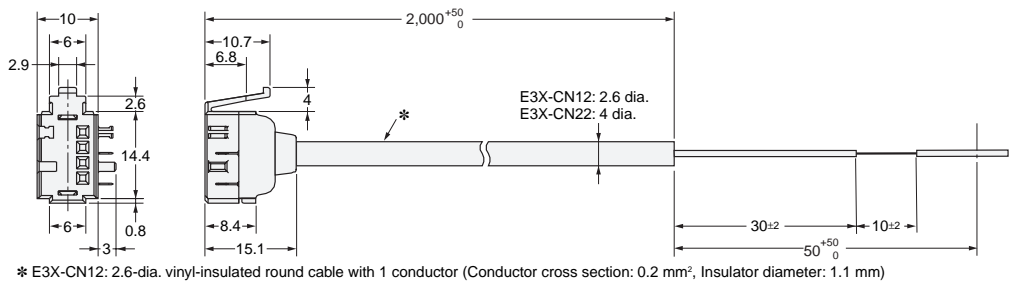
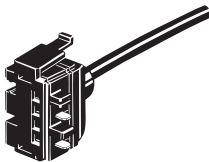

Refer to the *E32 Series Fiber Sensor Best Selection Guide (Cat. No. E353)*.

Operation

Operation Reference

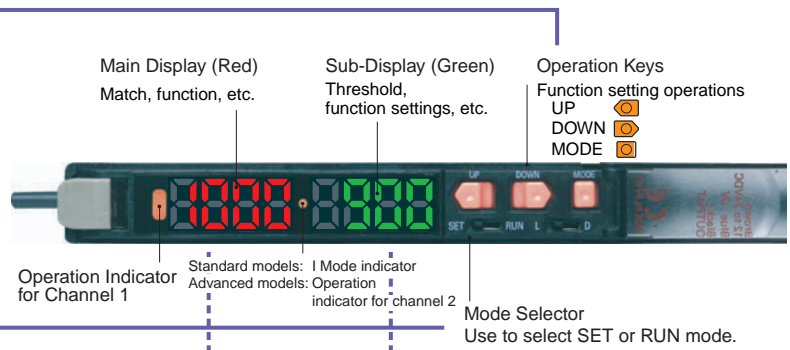

SET/RUN mode	Operation Keys	Operation	Displays		Remarks
			Main Display	Sub-Display	
Detection/adjustment RUN (Factory-set to RUN)		Adjusting thresholds	Incident level	Threshold	→ Page 20 Refer to 4. <i>Setting Thresholds Manually in RUN Mode.</i> Used to executes various teaching and zero-reset operations. → Page 20 Refer to 3. <i>Registering Workpiece Colors with Teaching in SET Mode.</i>
		Executing user-specified functions (Factory-set to 1-point teaching.)			
Function settings SET 		Changing teaching and setting details	Setting items	Setting details	→ Page 20 Refer to 3. <i>Registering Workpiece Colors with Teaching in SET Mode.</i> → Page 21 Refer to 5. <i>Setting Functions in SET Mode.</i>
		Switching setting items			

SET/RUN mode	Operation Keys	Operation	Display		Remarks
			Main Display	Sub-Display	
RUN (Factory-set to RUN)		Locking and unlocking keys	LOC 	ON 	Locks key operation to prevent incorrect operation. → Page 22 Refer to 6. <i>Convenient Functions.</i>
SET 		Initialization and user reset	INIT 	YES? 	Returns the system to its initial state. → Page 22 Refer to 6. <i>Convenient Functions.</i>

E3X-DAC-S

1 Changing Banks (for Advanced Models (4-color Determination))

The bank where data is registered can be changed by using the bank input and the channel switch.

Bank	A	B	C	D
Bank input	Open	Open	Closed	Closed
Channel switch	1 <input type="checkbox"/> 2	1 <input type="checkbox"/> 2	1 <input type="checkbox"/> 2	1 <input type="checkbox"/> 2
Display				

2 Setting the Operation Mode

The operation mode is set with the Mode Selector.

Operation mode		Operation
Match ON	L-ON	L <input type="checkbox"/> (Factory-set)
Mismatch ON	D-ON	<input type="checkbox"/> D

* Advanced Models

The operation mode is set in SET mode.

→ Page 21 Refer to 5. Setting Functions in SET Mode.

* Advanced Models

Set the Channel Selector to the desired channel before making any adjustments or settings. This is true for all adjustments and settings.

3 Registering Workpiece Colors with Teaching in SET Mode

* Workpiece colors must always be taught to perform judgment for registered workpiece colors.

* With the factory settings, 1-point teaching can be executed in RUN mode. (Press the MODE Key for 3 s.)

3-1. One-point Teaching

Along with registering the workpiece colors, the threshold can be set at approximately -10% of the match.

The setting is completed in a simple operation with one press of a button.

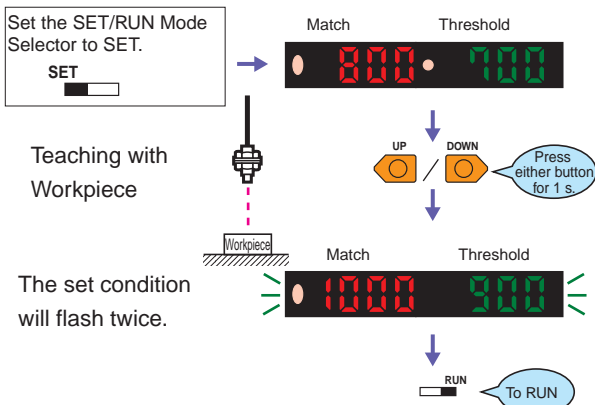

* The threshold level can be changed if the teaching level function is used in SET mode.

* If BLACK mode is selected as the judgment mode in SET mode, the threshold will be set to a level of approximately 10% higher than the displayed degree of matching.

3-2. Teaching with and without the Workpiece

Two points, with and without the workpiece, are detected, and the match of the intermediate point is set as the threshold value.

This method is ideal for setting thresholds with margins or performing judgments with low match.

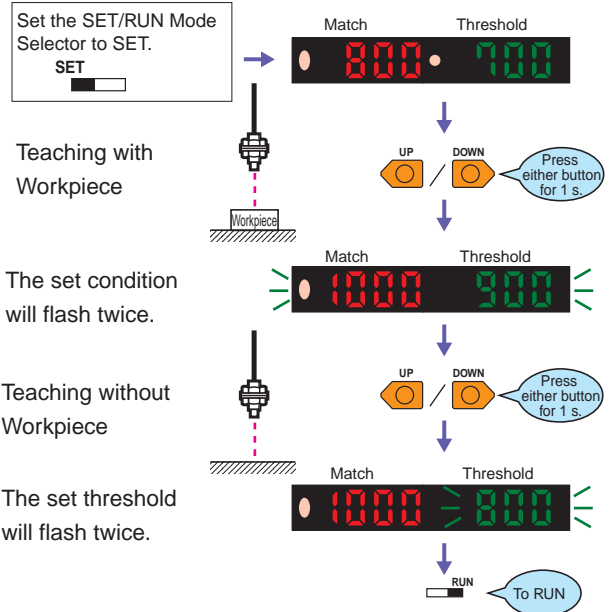

* When teaching is performed, position the workpiece by using the OVER, OK, and LO messages displayed on the sub-display (green) as guides.

	OVER : Move the workpiece away.
	OK : Teaching is possible.
	LO : Move the workpiece closer.

4 Setting Thresholds Manually in RUN Mode

A threshold can be set manually. A threshold value can also be fine-tuned using manual setting after teaching.

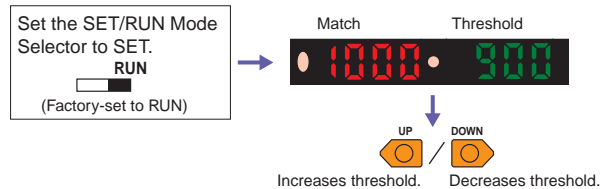

* Even if the display method for the Display Switch Function is changed, the threshold will appear on the sub-display when the key is pressed.

6 Convenient Functions

6-1. Zeroing the Display (Zero Reset)

The incident light level on the main display can be set to 0. This is useful when the reference display is to be reset to zero because the match display and the threshold are shifted at the same time.

* Change the function to 0RST (zero reset) with the MODE key. The default setting is 1PNT.
 → Page 21 Refer to 5. Setting Functions in SET Mode.

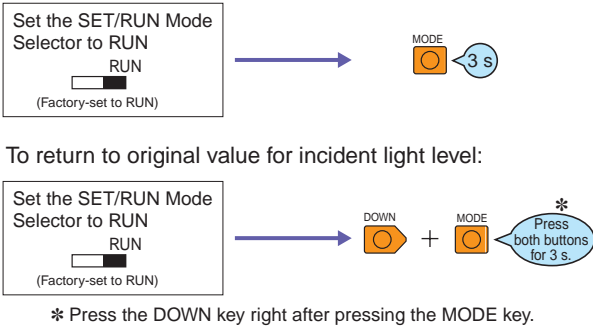

6-2. Locking the Keys (Key Lock)

All key operations can be disabled.

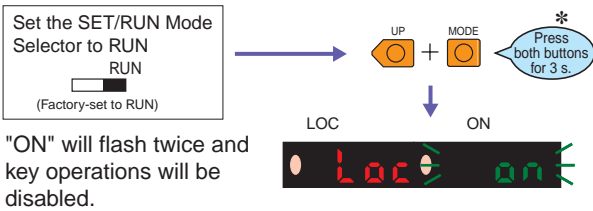

To release the lock:

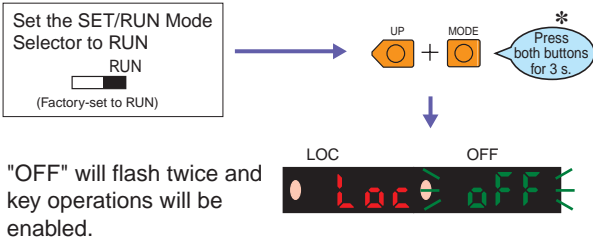

* If a key is pressed while key operations are locked, "LOC" will flash twice on the display to indicate that key operations have been disabled. → Loc

* Press the UP key right after pressing the MODE key.

6-3. Saving a Set State (Saving User Settings)

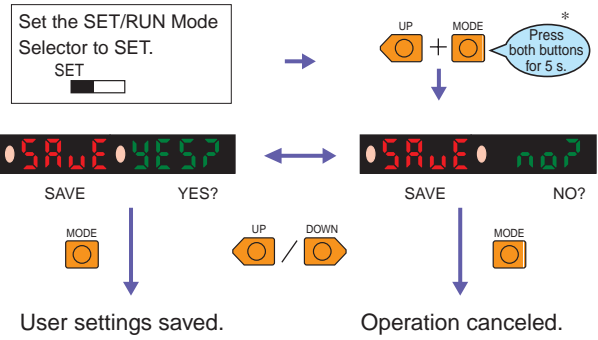

* Be sure to register (i.e., teach) the workpiece colors if the detection functions have been changed.

6-4. Initializing Settings (Initialization and User Reset)

All settings will be initialized and returned to the factory settings or to a saved state.

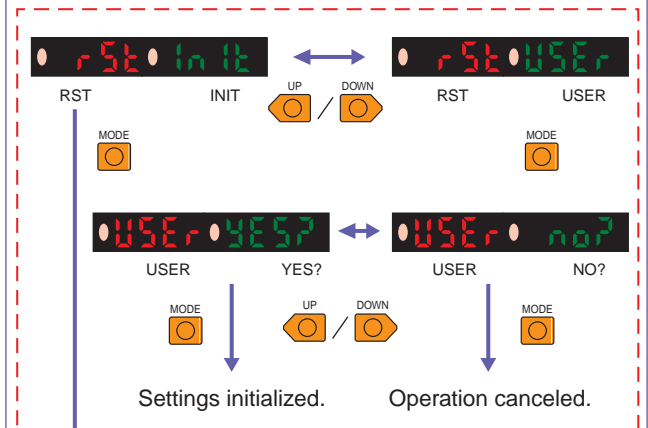

The section enclosed by dotted lines applies to user-saved settings.

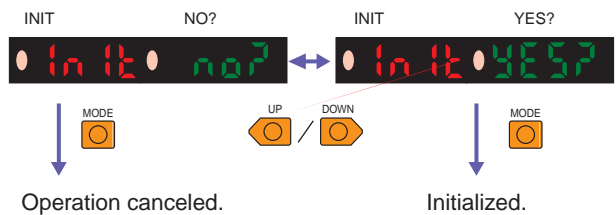

READ AND UNDERSTAND THIS DOCUMENT

Please read and understand this document before using the products. Please consult your OMRON representative if you have any questions or comments.

WARRANTY

OMRON's exclusive warranty is that the products are free from defects in materials and workmanship for a period of one year (or other period if specified) from date of sale by OMRON.

OMRON MAKES NO WARRANTY OR REPRESENTATION, EXPRESS OR IMPLIED, REGARDING NON-INFRINGEMENT, MERCHANTABILITY, OR FITNESS FOR PARTICULAR PURPOSE OF THE PRODUCTS. ANY BUYER OR USER ACKNOWLEDGES THAT THE BUYER OR USER ALONE HAS DETERMINED THAT THE PRODUCTS WILL SUITABLY MEET THE REQUIREMENTS OF THEIR INTENDED USE. OMRON DISCLAIMS ALL OTHER WARRANTIES, EXPRESS OR IMPLIED.

LIMITATIONS OF LIABILITY

OMRON SHALL NOT BE RESPONSIBLE FOR SPECIAL, INDIRECT, OR CONSEQUENTIAL DAMAGES, LOSS OF PROFITS OR COMMERCIAL LOSS IN ANY WAY CONNECTED WITH THE PRODUCTS, WHETHER SUCH CLAIM IS BASED ON CONTRACT, WARRANTY, NEGLIGENCE, OR STRICT LIABILITY.

In no event shall responsibility of OMRON for any act exceed the individual price of the product on which liability is asserted.

IN NO EVENT SHALL OMRON BE RESPONSIBLE FOR WARRANTY, REPAIR, OR OTHER CLAIMS REGARDING THE PRODUCTS UNLESS OMRON'S ANALYSIS CONFIRMS THAT THE PRODUCTS WERE PROPERLY HANDLED, STORED, INSTALLED, AND MAINTAINED AND NOT SUBJECT TO CONTAMINATION, ABUSE, MISUSE, OR INAPPROPRIATE MODIFICATION OR REPAIR.

SUITABILITY FOR USE

THE PRODUCTS CONTAINED IN THIS DOCUMENT ARE NOT SAFETY RATED. THEY ARE NOT DESIGNED OR RATED FOR ENSURING SAFETY OF PERSONS, AND SHOULD NOT BE RELIED UPON AS A SAFETY COMPONENT OR PROTECTIVE DEVICE FOR SUCH PURPOSES. Please refer to separate catalogs for OMRON's safety rated products.

OMRON shall not be responsible for conformity with any standards, codes, or regulations that apply to the combination of products in the customer's application or use of the product.

At the customer's request, OMRON will provide applicable third party certification documents identifying ratings and limitations of use that apply to the products. This information by itself is not sufficient for a complete determination of the suitability of the products in combination with the end product, machine, system, or other application or use.

The following are some examples of applications for which particular attention must be given. This is not intended to be an exhaustive list of all possible uses of the products, nor is it intended to imply that the uses listed may be suitable for the products:

- Outdoor use, uses involving potential chemical contamination or electrical interference, or conditions or uses not described in this document.
- Nuclear energy control systems, combustion systems, railroad systems, aviation systems, medical equipment, amusement machines, vehicles, safety equipment, and installations subject to separate industry or government regulations.
- Systems, machines, and equipment that could present a risk to life or property.

Please know and observe all prohibitions of use applicable to the products.

NEVER USE THE PRODUCTS FOR AN APPLICATION INVOLVING SERIOUS RISK TO LIFE OR PROPERTY WITHOUT ENSURING THAT THE SYSTEM AS A WHOLE HAS BEEN DESIGNED TO ADDRESS THE RISKS, AND THAT THE OMRON PRODUCT IS PROPERLY RATED AND INSTALLED FOR THE INTENDED USE WITHIN THE OVERALL EQUIPMENT OR SYSTEM.

PERFORMANCE DATA

Performance data given in this document is provided as a guide for the user in determining suitability and does not constitute a warranty. It may represent the result of OMRON's test conditions, and the users must correlate it to actual application requirements. Actual performance is subject to the OMRON Warranty and Limitations of Liability.

CHANGE IN SPECIFICATIONS

Product specifications and accessories may be changed at any time based on improvements and other reasons.

It is our practice to change model numbers when published ratings or features are changed, or when significant construction changes are made. However, some specifications of the product may be changed without any notice. When in doubt, special model numbers may be assigned to fix or establish key specifications for your application on your request. Please consult with your OMRON representative at any time to confirm actual specifications of purchased products.

DIMENSIONS AND WEIGHTS

Dimensions and weights are nominal and are not to be used for manufacturing purposes, even when tolerances are shown.

ERRORS AND OMISSIONS

The information in this document has been carefully checked and is believed to be accurate; however, no responsibility is assumed for clerical, typographical, or proofreading errors, or omissions.

PROGRAMMABLE PRODUCTS

OMRON shall not be responsible for the user's programming of a programmable product, or any consequence thereof.

COPYRIGHT AND COPY PERMISSION

This document shall not be copied for sales or promotions without permission.

This document is protected by copyright and is intended solely for use in conjunction with the product. Please notify us before copying or reproducing this document in any manner, for any other purpose. If copying or transmitting this document to another, please copy or transmit it in its entirety.

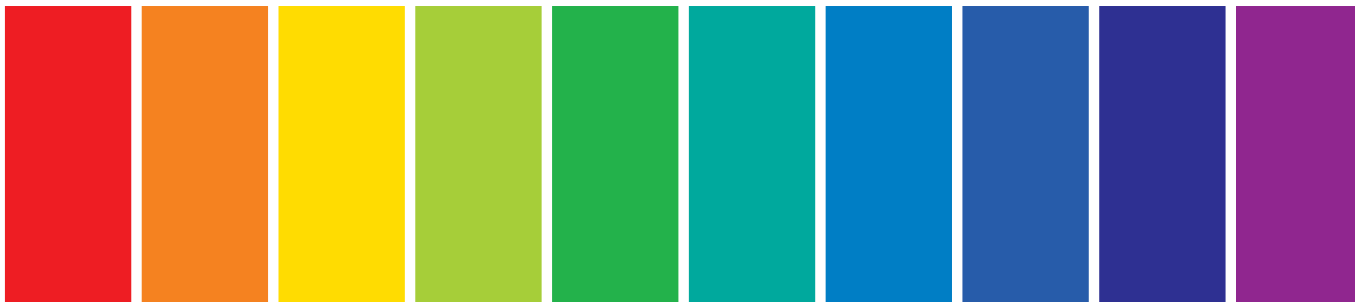

OMRON Corporation Industrial Automation Company

Tokyo, JAPAN

Contact: www.ia.omron.com

Regional Headquarters

OMRON EUROPE B.V.

Wegalaan 67-69-2132 JD Hoofddorp
The Netherlands
Tel: (31)2356-81-300/Fax: (31)2356-81-388

OMRON ASIA PACIFIC PTE. LTD.

No. 438A Alexandra Road # 05-05/08 (Lobby 2),
Alexandra Technopark,
Singapore 119967
Tel: (65) 6835-3011/Fax: (65) 6835-2711

OMRON SCIENTIFIC TECHNOLOGIES INC.

6550 Dumbarton Circle, Fremont
CA 94555-3605 U.S.A.
Tel: (1) 510-608-3400/Fax: (1) 510-744-1442

OMRON (CHINA) CO., LTD.

Room 2211, Bank of China Tower,
200 Yin Cheng Zhong Road,
PuDong New Area, Shanghai, 200120, China
Tel: (86) 21-5037-2222/Fax: (86) 21-5037-2200

Authorized Distributor:

© OMRON Corporation 2009 All Rights Reserved.
In the interest of product improvement,
specifications are subject to change without notice.

CSM_4_1_1112
Cat. No. E384-E1-03

Printed in Japan
0910