

MITSUBISHI

A7GT-BUSS Bus Connection Interface Module

Mitsubishi General Purpose PC User's Manual

Thank you for choosing the Mitsubishi General Purpose PC Graphic Operation Terminal 800 series. To ensure correct use of this equipment, please read this manual carefully before operating it.



MODEL	A7GT-BUSS-U-E
MODEL CODE	13JL07

IB-NA-66760-A (9704) MEE

●SAFETY PRECAUTIONS●

(Read these precautions before using.)

When using Mitsubishi equipment, thoroughly read this manual and the associated manuals introduced in this manual. Also pay careful attention to safety and handle the module properly.

These precautions apply only to Mitsubishi equipment. Refer to the CPU module user's manual for a description of the PC system safety precautions.

These ●SAFETY PRECAUTIONS● classify the safety precautions into two categories: "DANGER" and "CAUTION"

DANGER

Procedures which may lead to a dangerous condition and cause death or serious injury if not carried out properly.

CAUTION

Procedures which may lead to a dangerous condition and cause superficial to medium injury, or physical damage only, if not carried out properly.

Depending on circumstances, procedures indicated by  CAUTION may also be linked to serious results.

In any case, it is important to follow the directions for usage.

Store this manual in a safe place so that you can take it out and read it whenever necessary. Always forward it to the end user.

[DESIGN PRECAUTIONS]

CAUTION

- Do not bunch the bus connection cables with the main circuit or power wires, or install them close to each other. They should be installed 100 mm (3.9 inch) or more from each other. Failure to do so may result in noise that would cause malfunctioning.

[INSTALLATION PRECAUTIONS]

DANGER

- When installing and removing this module from the GOT main module be sure to shut off the power at all external switches. If all the switches are not turned off, the module could be damaged or malfunction.
- When connecting the bus connection cable to this module be sure to turn off the switch to all external power switches to the GOT and PC CPU. If all the switches are not turned off, it may cause malfunction.

CAUTION

- Use this module in an environment that is within the general specifications written in the GOT User's Manual. If the power supply is used in an environment that is outside of the general specifications then electric shock, fire, malfunction, or product damage or degradation could occur.
- For a correct installation, insert the bus connection cable to this module, A7GT-BUS2S, bus connector conversion module, and base unit connector until you hear it click.
A bad connection could cause erroneous input or output.
- When installing this module in the GOT main module, install it in the GOT installation area and be sure it is fastened with a module fastening screw that is tightened within the specified torque range.
If the module fixing screws are loosen, it may cause malfunction, damage or falling of the module.
If the module fixing screws are too tight, the GOT main module or the screws could break.

[STARTING AND MAINTENANCE PRECAUTIONS]

DANGER

- Do not change the switch setting while power is on.
- Switch all phases of the GOT external power supply off before cleaning. Not doing so could result in electric shock.

CAUTION

- Never disassemble or modify the module. This may cause breakdowns, malfunctioning, injury, and/or fire.
- Do not directly touch the conducted area and electric parts of this module. It may cause damage and malfunctioning of the module.
- This module is made of resinous materials, and should be protected from strong shock or impact. It may cause breakdown.

[DISPOSAL PRECAUTIONS]

CAUTION

- When disposing of this product, treat it as industrial waste.

About This Manual

The following product manuals are available. Please use this table as a reference to request the appropriate manual as necessary.

Detailed Manual

Manual Name	Manual No. (Type Code)
A77GOT-S5 Graphic Operation Terminal User's Manual (Packaged with the A77GOT-S5)	IB-66548 (13JE88)
A870GOT Graphic Operation Terminal User's Manual (Packaged with the A870GOT)	IB-86628 (13J830)
A850GOT Graphic Operation Terminal User's Manual (Packaged with the A850GOT)	IB66669 (13J847)
Additional Explanation for A810GOT Graphic Operation Terminal (Packaged with the A810GOT)	IB-86766 (13JL14)
A7GT-BUS2S Multidrop Bus Connection Module User's Manual (Packaged with the A7GT-BUS2S)	IB-86761 (13JL08)

Table of Contents

1 Overview	1
2 Components Including in the Package	2
3 Specifications	2
3.1 Performance Specifications	2
3.2 Applicable Bus Connection Cables	3
4 Name of Each Part and Setting	4
5 Installation Method	6
6 External Dimensions Diagram	7
6.1 External Dimensions Diagram	7
6.2 Rear Dimension Diagram When Bus Connection Cable is Connected	7

1 Overview

This User's Manual describes the specification, name and setting of each part, and the installation method of A7GT-BUSS bus connection interface module (abbreviated as A7GT-BUSS hereafter).

The A7GT-BUSS module is used when connecting A77GOT-S5/ A870GOT/A850GOT/A810GOT Graphic Operation Terminals (abbreviated as GOT hereafter) using the bus connection.

The A7GT-BUSS module can be used in the following system configurations:

- 1) When a GOT is connected to one PC CPU.
- 2) In a system where multiple GOTs are connected to one PC CPU, use this module for the final GOT

Because the module has a structure where the bus connection cable is attached at the bottom, it does not require a space for the depth of the connector for the bus connection cable or of the cable bending dimension even when installed to a control box, etc.

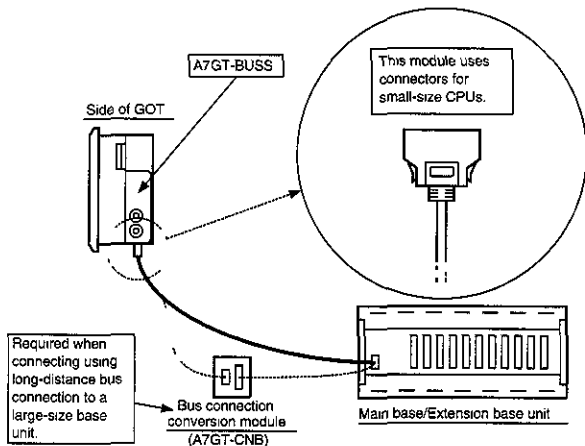

Note: The A7GT-BUSS cannot be used with A7GT-BUS2 at the same time.

2 Components Including in the Package

After opening the container, check that the following products are present.

Description	Quantity
Bus connection module main module	1
This manual	1

3 Specifications

3.1 Performance Specifications

The A7GT-BUSS performance specifications are shown below.

Item	Specifications
I/O assignment	Special 32 points
Weight	170 g
External dimensions mm [inch]	99 [3.90] (H) x 149 [5.87] (D) x 34 [1.34] (W)

For the general specification, refer to the User's Manual of the GOT in use.



2 Applicable Bus Connection Cables

Bus connection cables applicable for the use with A7GT-BUSS are listed below:

Connecting destination	Model name	Cable length
Large-sized base unit	A8GT-C12NB	1.2m (3.94ft.)
	A8GT-C30NB	3m (9.84ft.)
	A8GT-C50NB	5m (16.41ft.)
Small-sized base unit	A1SC07B	0.7m (2.30ft.)
	A1SC12B	1.2m (3.94ft.)
	A1SC30B	3m (9.84ft.)
	A1SC50B	5m (16.41ft.)
	A1SC60B	6m (19.69ft.)
	A8GT-C100EXSS	10m (32.81ft.)
	A8GT-C200EXSS	20m (65.62ft.)
	A8GT-C300EXSS	30m (98.43ft.)
GOT (when multiple modules are connected)	A1SC07B	0.7m (2.30ft.)
	A1SC12B	1.2m (3.94ft.)
	A1SC30B	3m (9.84ft.)
	A1SC50B	5m (16.41ft.)
	A1SC60B	6m (19.69ft.)
	A8GT-C100BS	10m (32.81ft.)
	A8GT-C200BS	20m (65.62ft.)
	A8GT-C300BS	30m (98.43ft.)
A7GT-CNB bus connector conversion box	A8GT-C100EXSS	10m (32.81ft.)
	A8GT-C200EXSS	20m (65.62ft.)
	A8GT-C300EXSS	30m (98.43ft.)

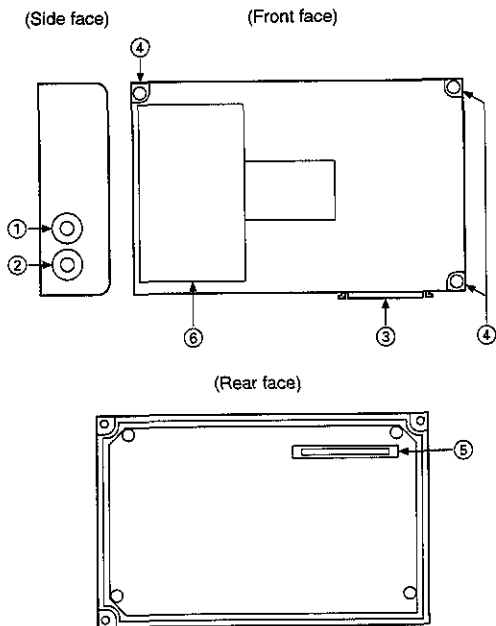
4 Name of Each Part and Setting



No.	Name	Description
①	Extension stage number setting switch 	Set a number of extension stage to be assigned for GOT. (Factory setting: 0) <Setting range> 1 to 7: Number of extension stage 8, 9, 0: Unusable
②	I/O slot setting switch 	Set an I/O slot number to be assigned for GOT. (Factory setting: 0) <Setting range> 0 to 7: I/O slot No. 8, 9: Unusable
③	Interface for bus connection cable	Interface to connect the bus connection cable
④	Module fixing screw	Fixing screw to the GOT
⑤	Connector	Connector to the GOT
⑥	Rated name plate	—

- * For details of setting methods of the module setting switch and I/O slot setting switch, refer to the User's Manual of the GOT in use.

5 Installation Method

The installation and removal methods of the memory cassette to and from the GOT are described below:

(1) Installation

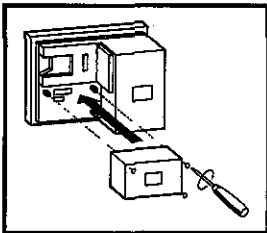

- ① Insert the interface module to the GOT installation area along the guide in the screw section.
- ② Install the module securely by tightening the module fixing screws (three pieces) with the specified torque (39 to 59N·cm (4 to 6 kg·cm)).

(2) Removal

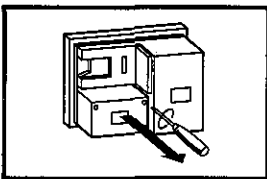

- ① Remove the module fixing screws (three pieces) and pull out the module horizontally.
- ② Keep the removed interface module in a safe place.

External Dimensions Diagram

1 External Dimensions Diagram

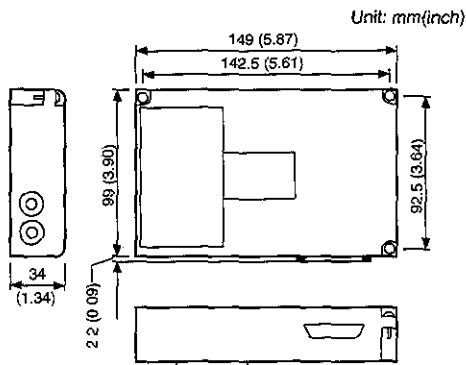

2 Rear Dimension Diagram When Extension Cable is Connected

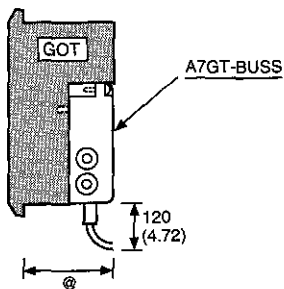

The dimension @ varies depending on the GOT model used.

GOT	@
A870GOT	83
A850GOT	90
A77GOT-S5	90

The United States	Mitsubishi Electronics America, Inc., (Industrial Automation Division) 800 Biemann Court, Mt. Prospect, IL 60056. Phone : (708) 298-9223
Canada	Mitsubishi Electric Sales Canada, Inc., (Industrial Automation Division) 4299 14th Avenue, Markham, Ontario L3R 0J2 Phone : (416) 475-7728
United Kingdom	Mitsubishi Electric UK Ltd., (Industrial Sales Division) Travellers Lane, Hatfield, Herts.. AL10 8XB Phone : (0707) 276100
Germany	Mitsubishi Electric Europe GmbH, (Industrial Automation Division) Gothaer Strasse 8, Postfach 1549, D-4030 Ratingen 1 Phone : (02102) 4860
Tawan	Setsuyo Enterprise Co., Ltd., (106) 11th Fl., Chung-Ling Bldg., 363, Sec. 2, Fu-Hsing S. Rd., Taipei, Tawan, R.O.C. Phone : (02) 732-0161
Hongkong (& China)	Ryoden International Ltd., (Industrial & Electrical Controls Division) 10/F., Manulife Tower, 169 Electric Rd., North Point, Hong Kong. Phone : 8878870
Singapore (& Malaysia)	MELCO Sales Singapore Pte. Ltd., (Industrial Division) 307 Alexandra Rd. #06-01/02, Mitsubishi Electric Bldg., Singapore 0315. Phone : 4732308
Thailand	F.A. Tech Co., Ltd., 1138/33-34 Rama 3 Rd., Yannawa, Bangkok 10120. Phone : (02) 295-2861-4
Australia	Mitsubishi Electric Australia Pty. Ltd., (Industrial Controls Division) 348 Victoria Rd., Rydalm ere, N.S.W. 2116. Phone : (02) 684-7200
Republic of South Africa	M.S.A. Manufacturing (Pty) Ltd., (Factory Automation Division) P.O. Box 39733, Bramley, Johannesburg 2018. Phone : (011) 444-8080



MITSUBISHI ELECTRIC CORPORATION

HEAD OFFICE: MITSUBISHI DENKI BLDG. MARUJOUCHI TORIY 100 TEL. EX. 2642 CABLE MELCO TOKYO
NAGOYA WORKS: 3-14, YADA-MENASHI 5, HIGASHI-KU, NAGOYA, JAPAN

When exported from Japan, this manual does not require application to the Ministry of International Trade and Industry for service transaction permission.